

BRICK BY BRICK: LEGO SHIPBUILDING

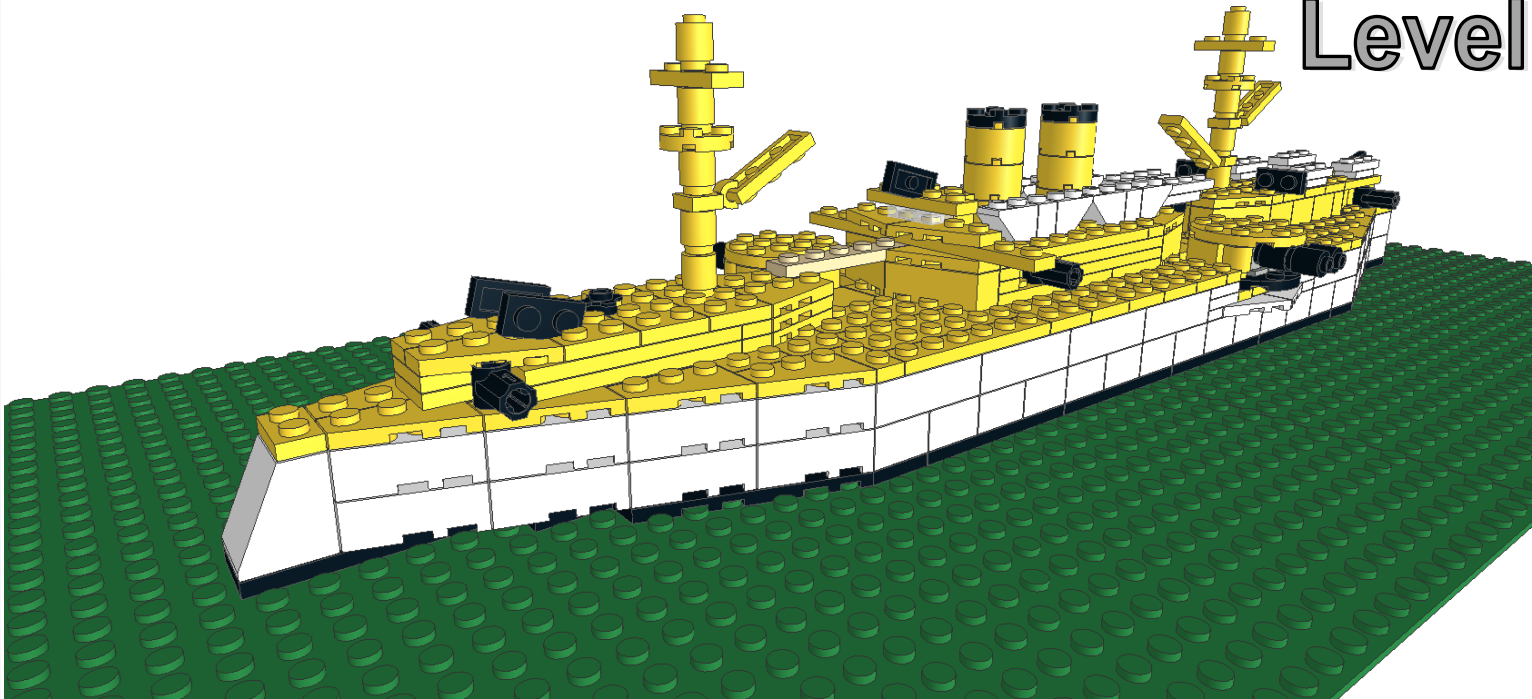

USS *Maine* Level: Expert



Ship models included in this program are built with LEGO® bricks. LEGO® is a trademark of the LEGO® group of companies which does not sponsor, authorize, or endorse this program.

www.hrnmm.navy.mil



Parts and Pieces

USS MAINE

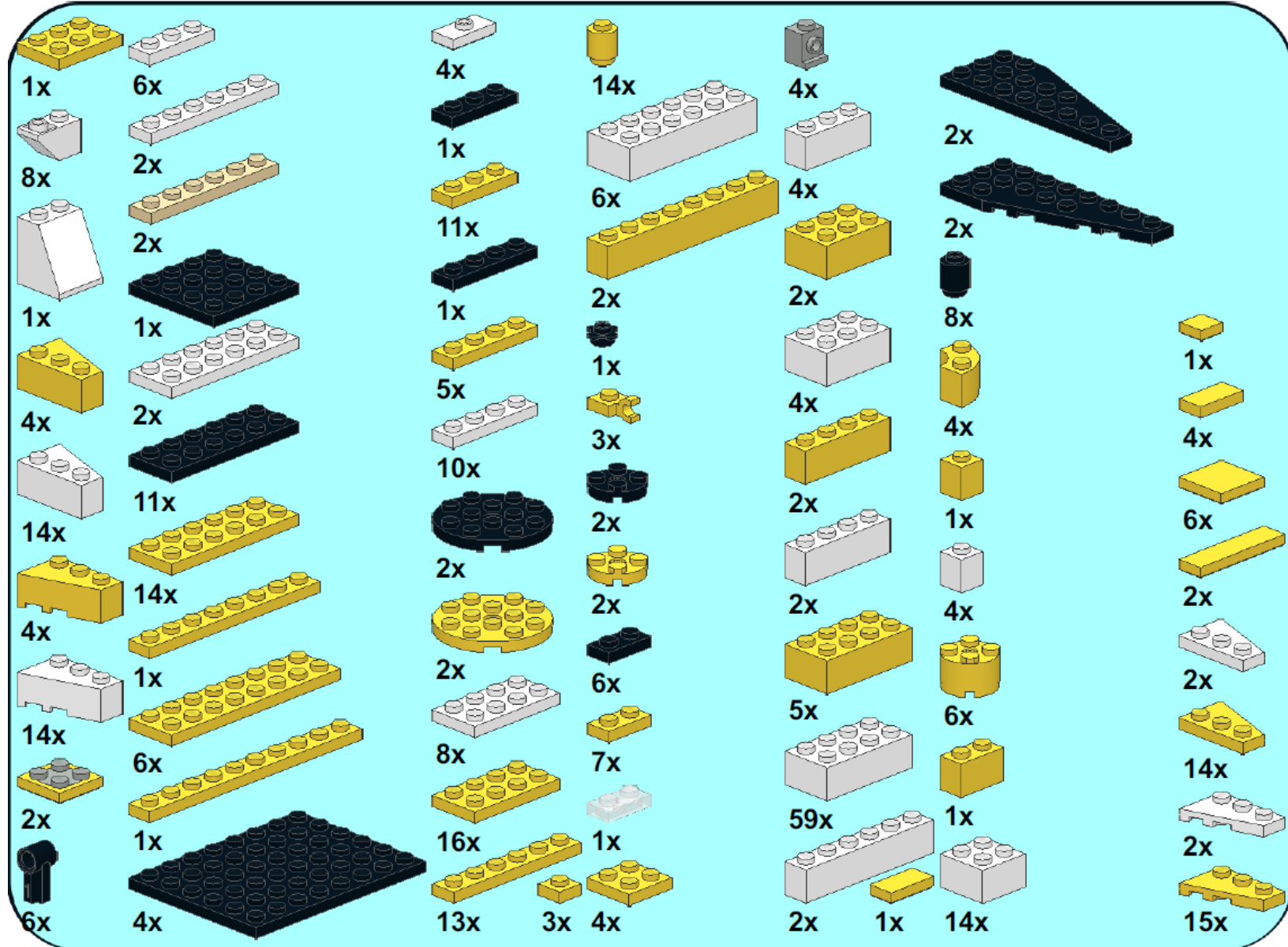

STEP 1

USS MAINE

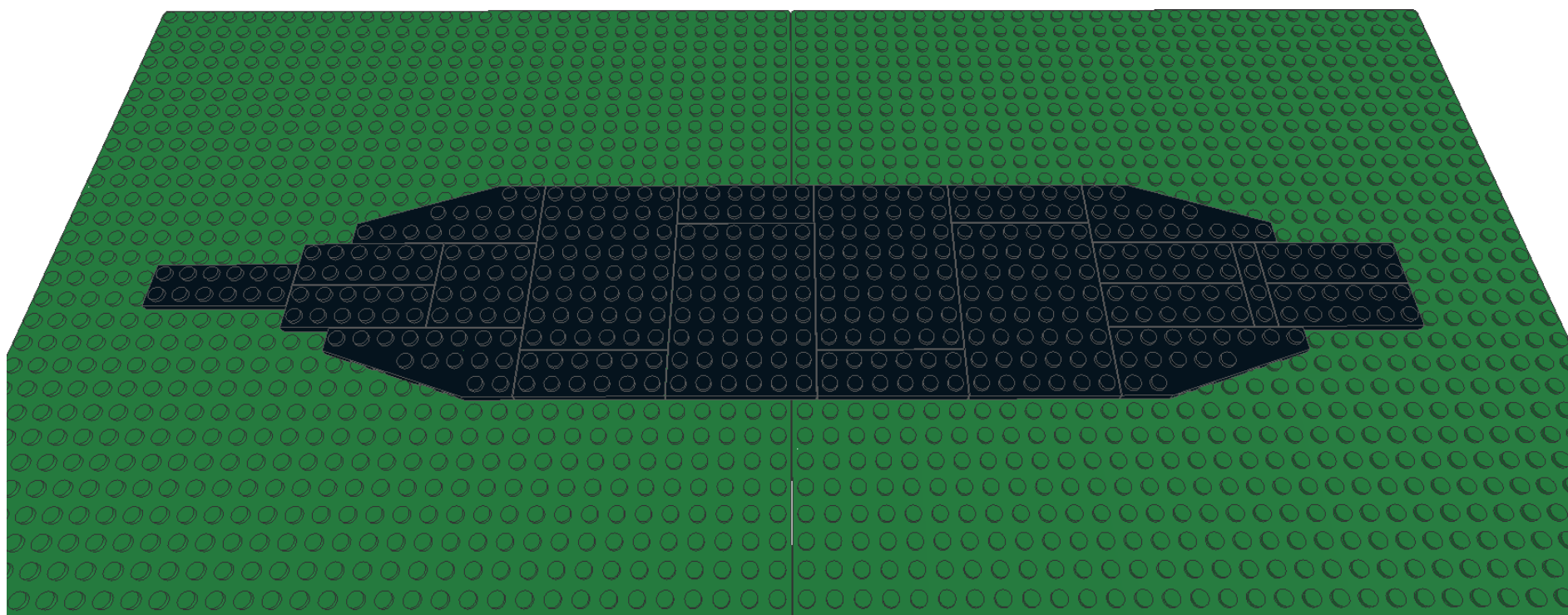
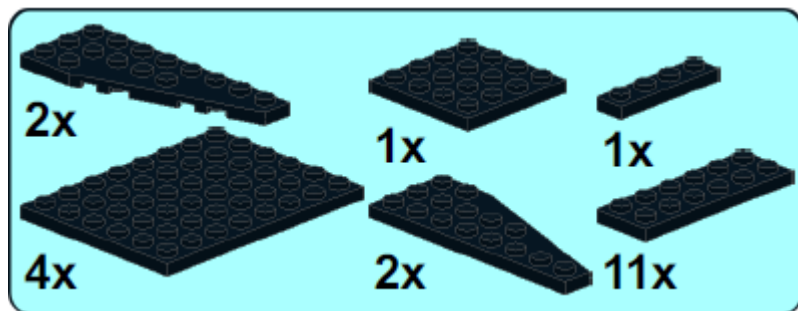

STEP 2

USS MAINE

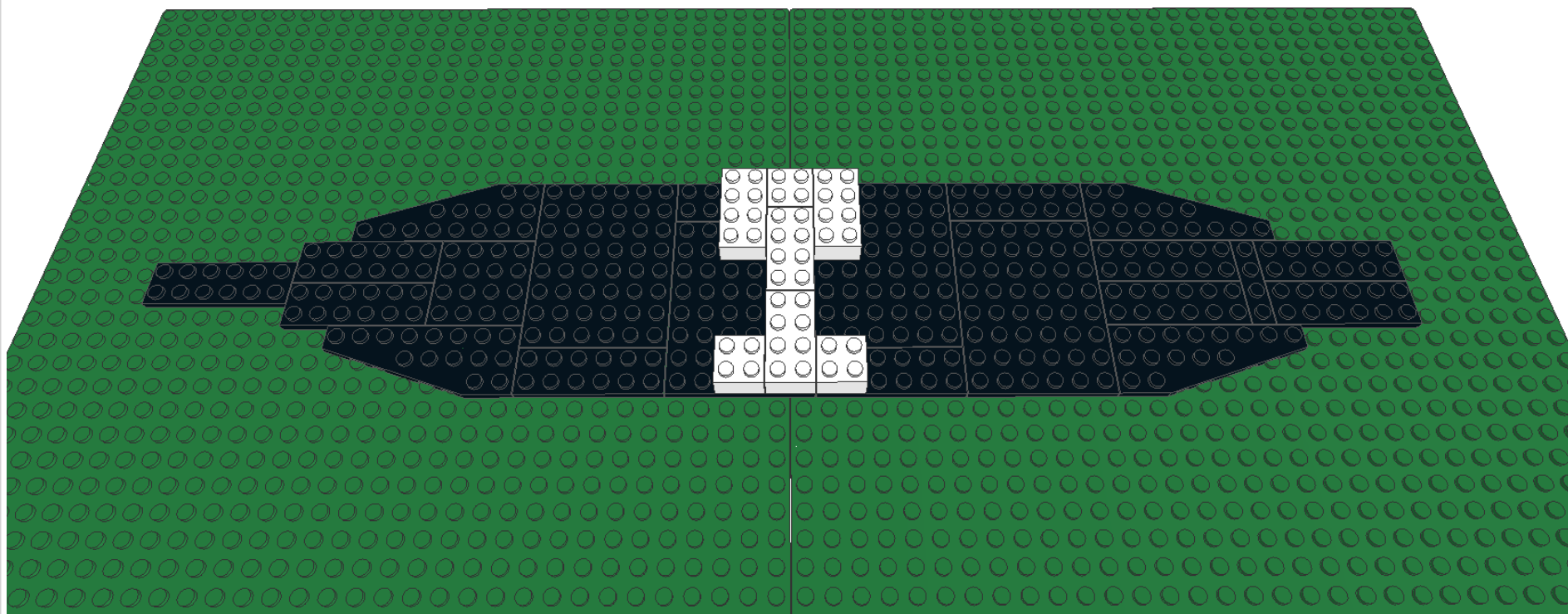
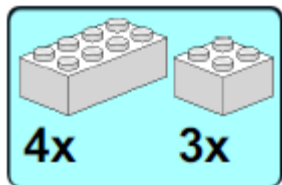

STEP 3

USS MAINE

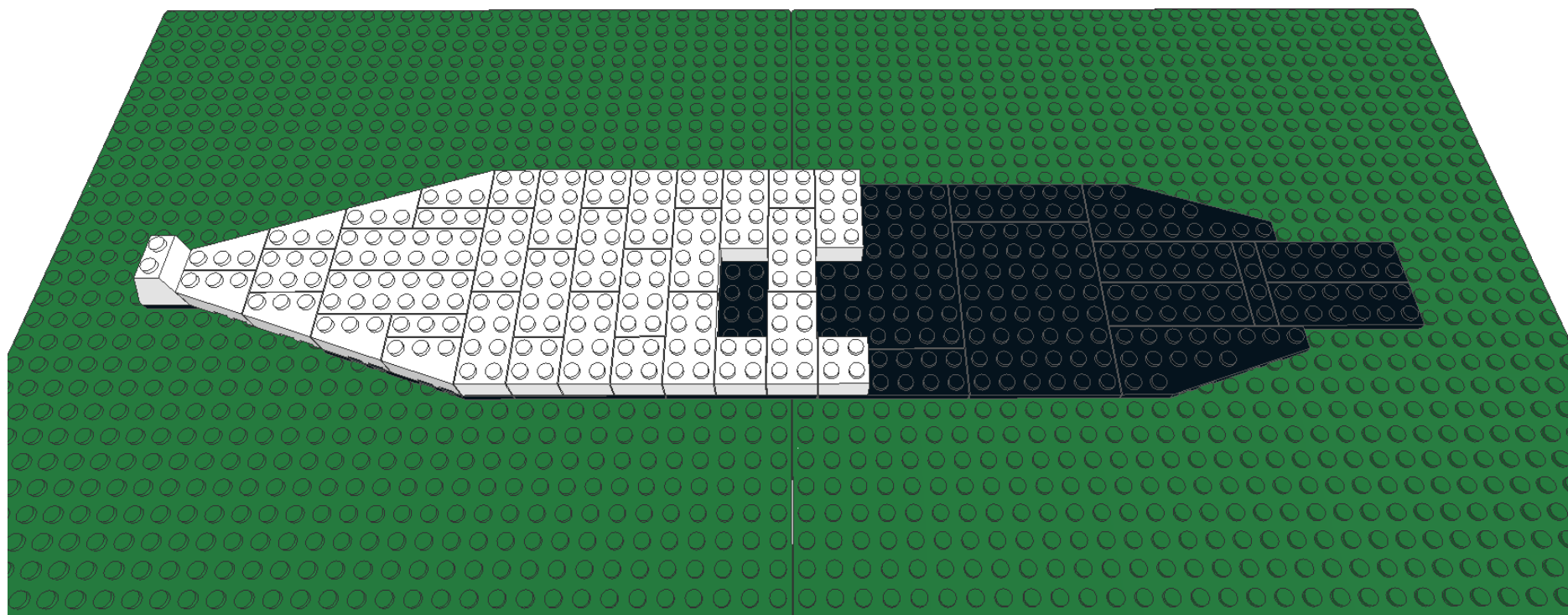
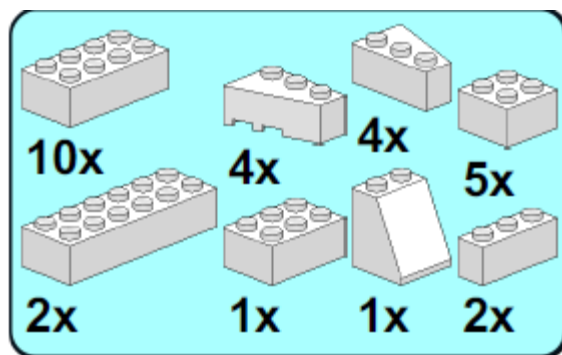

STEP 4

USS MAINE

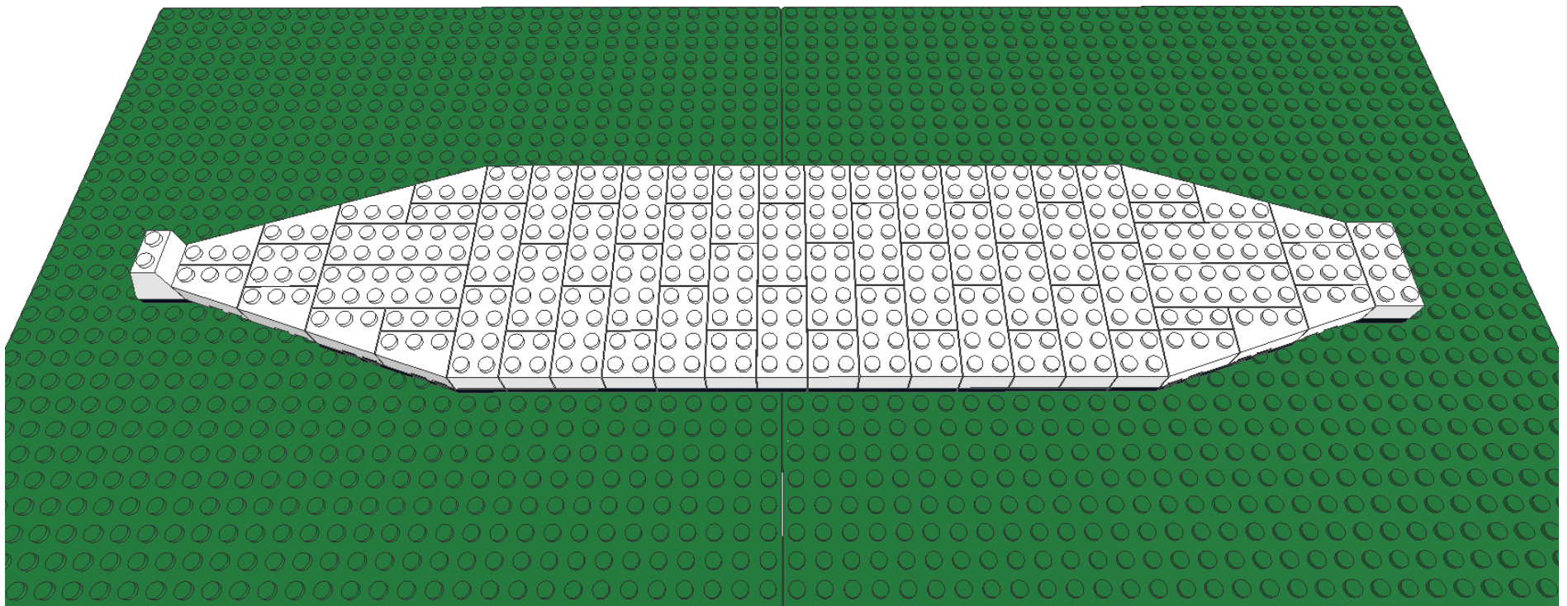
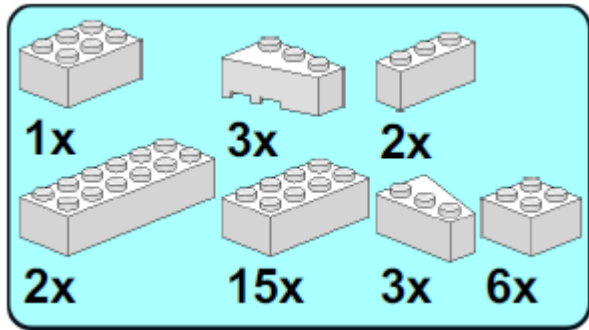

STEP 5

USS MAINE

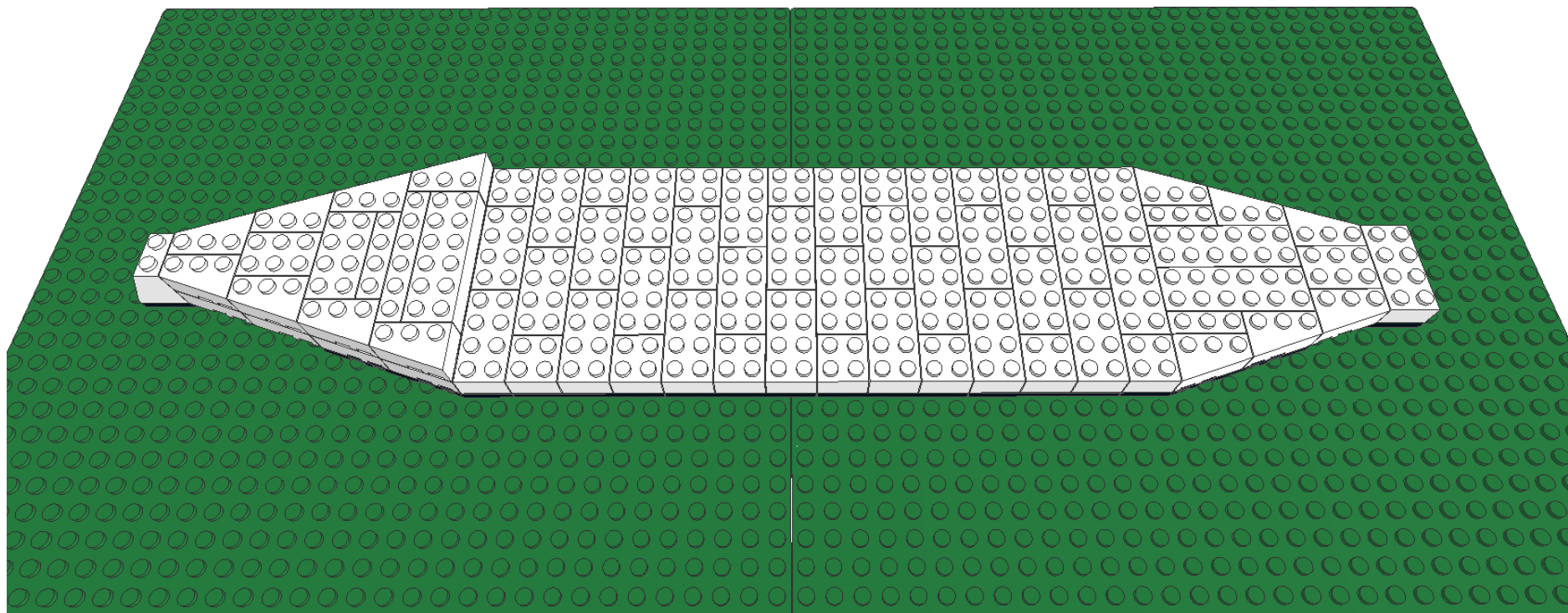
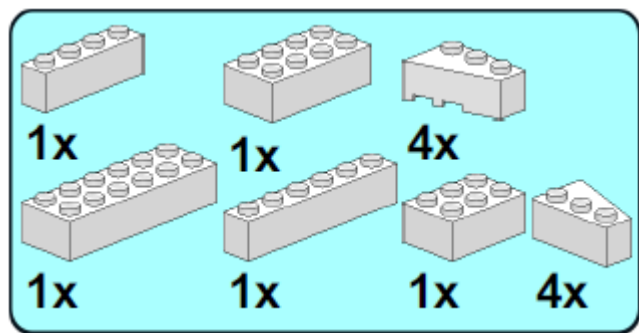

STEP 6

USS MAINE

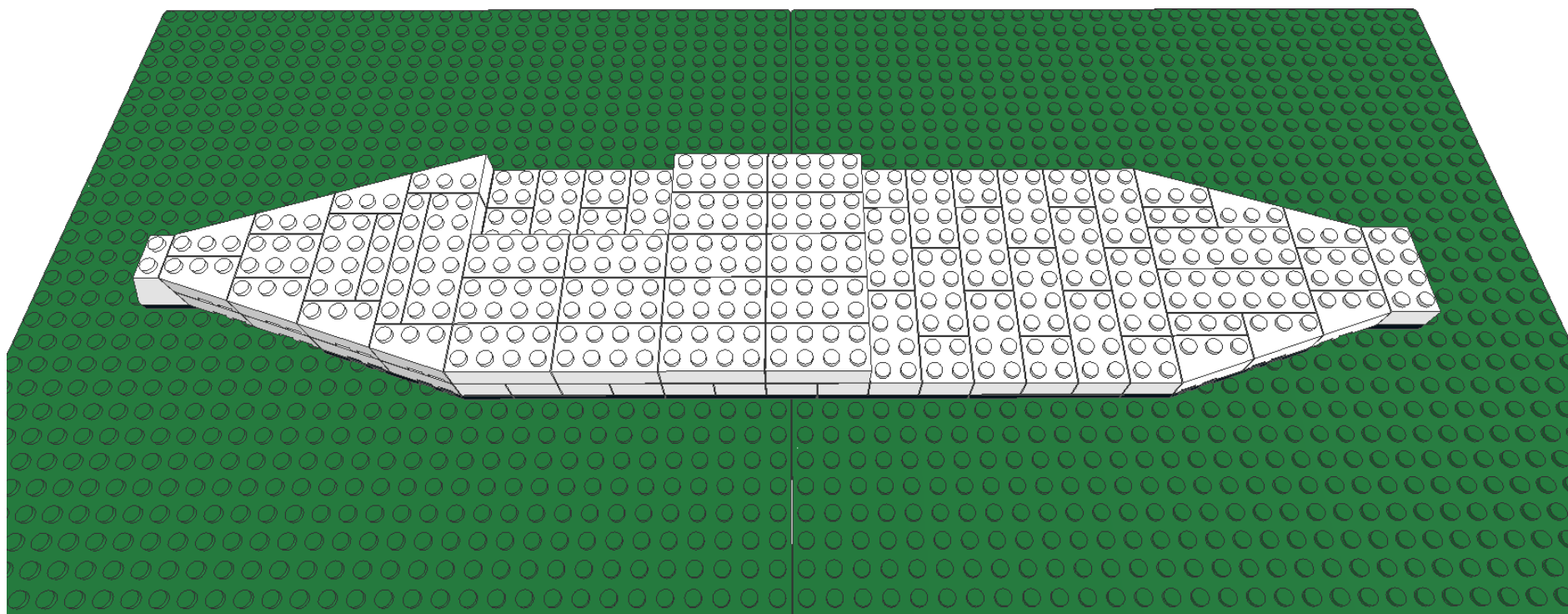
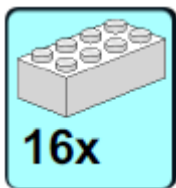

STEP 7

USS MAINE

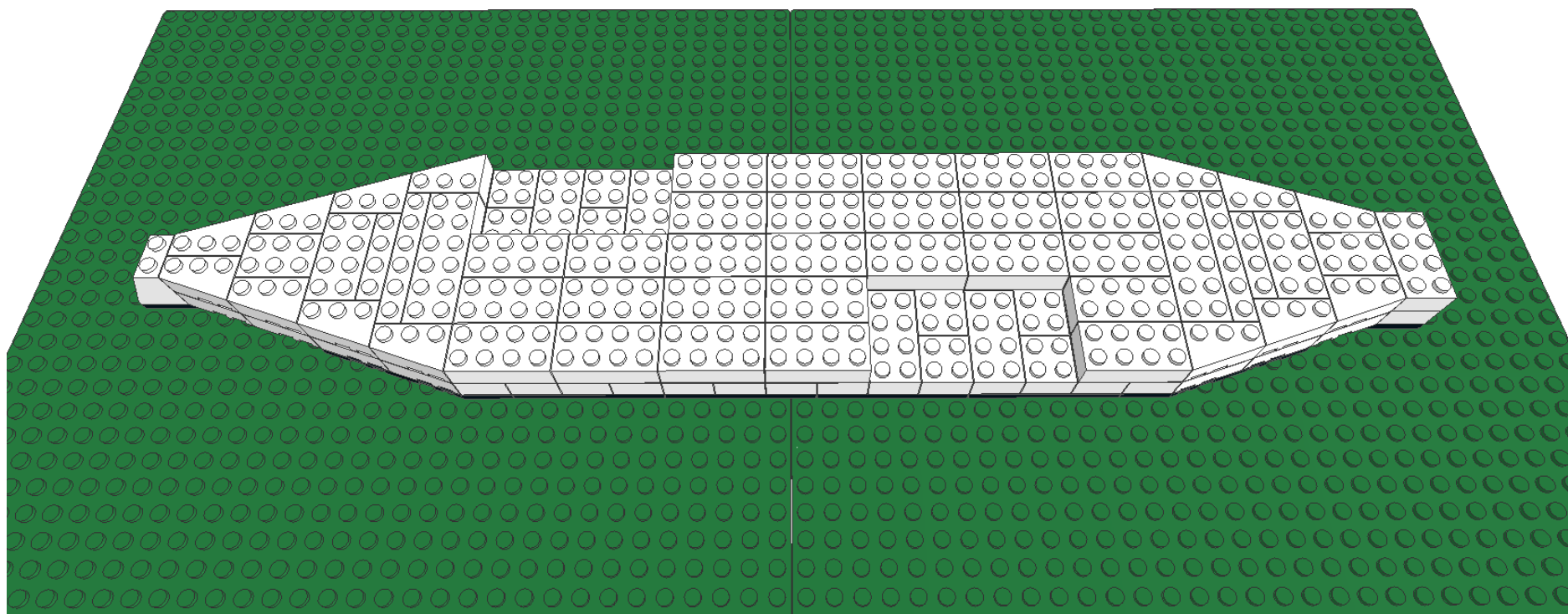
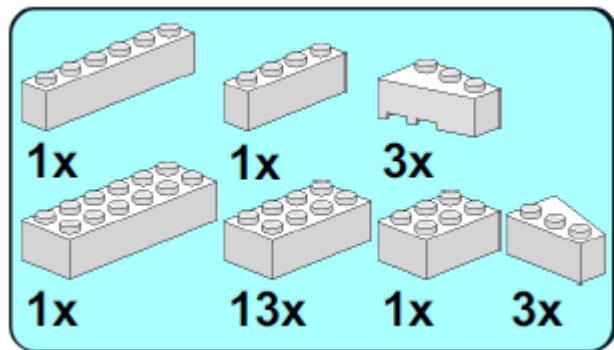

STEP 8

USS MAINE

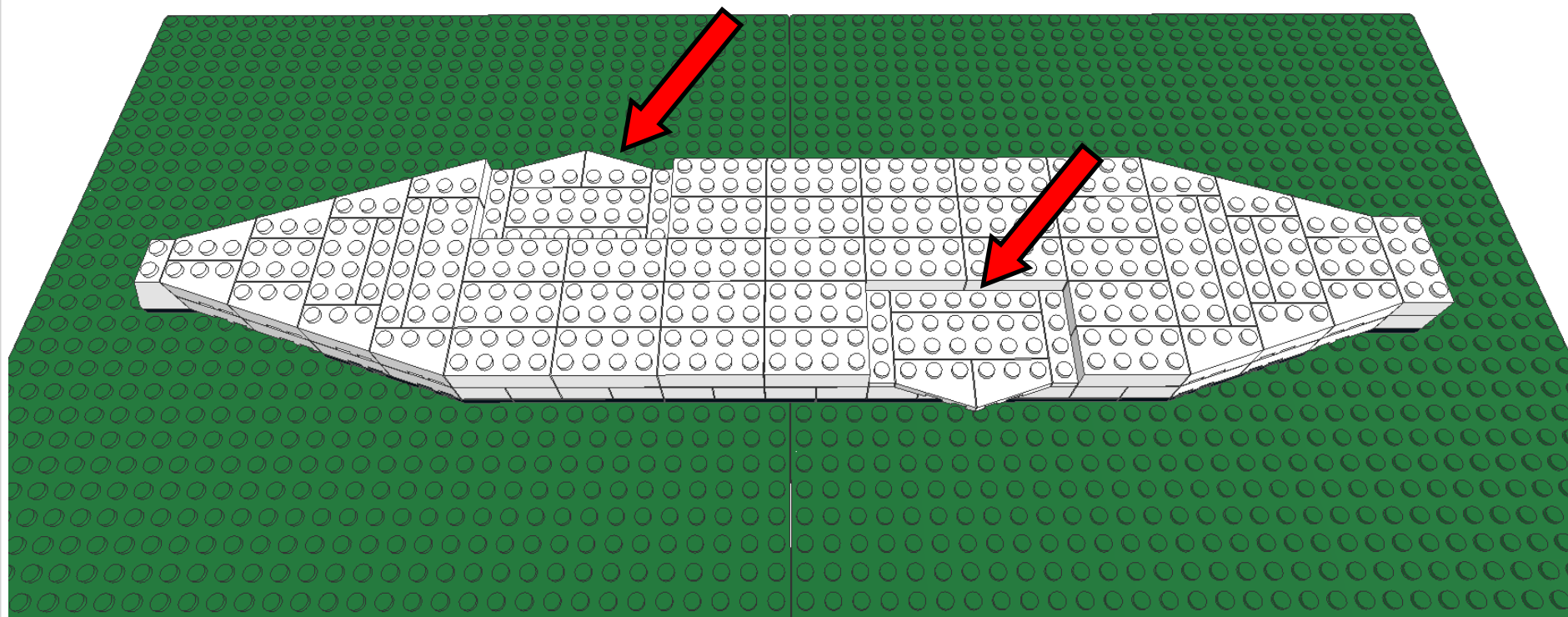
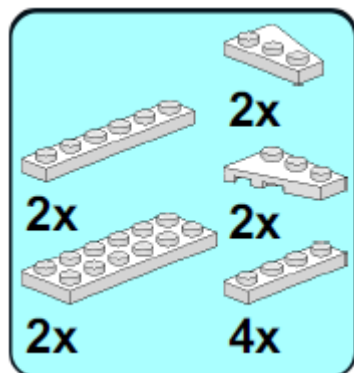

STEP 9

USS MAINE

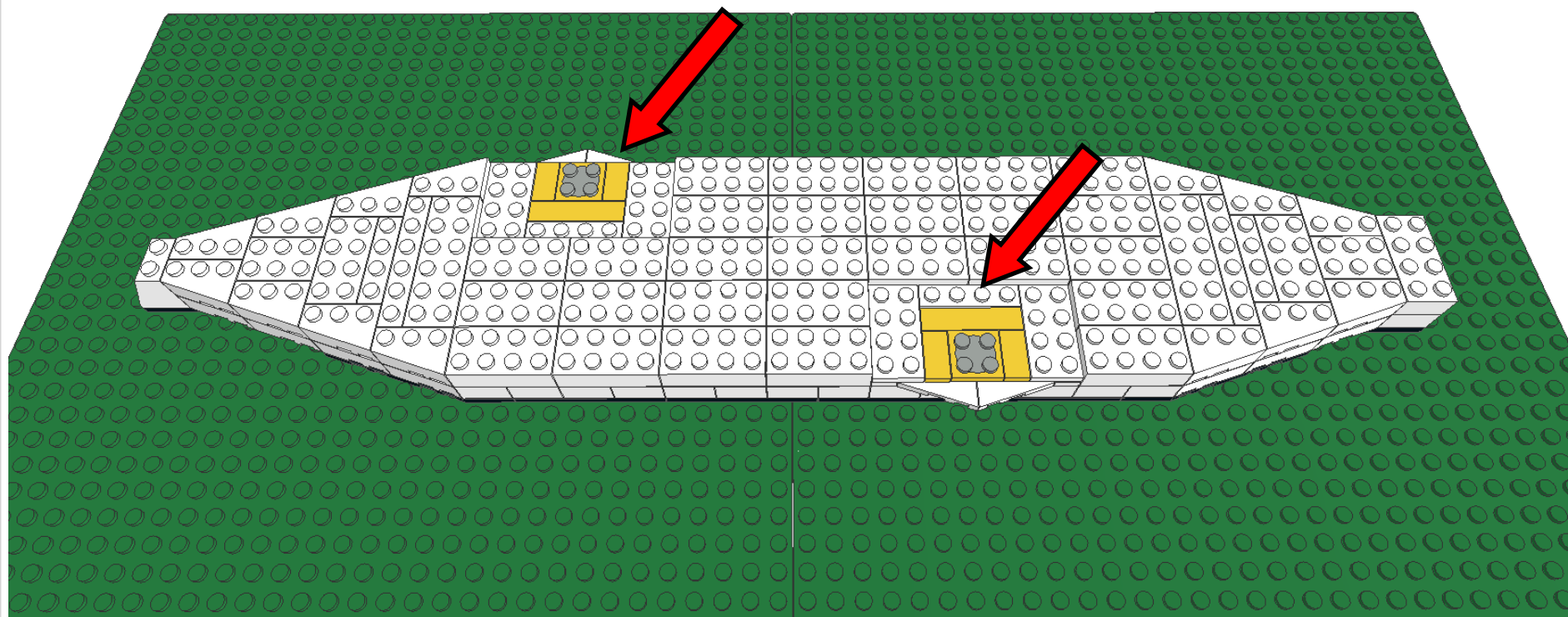
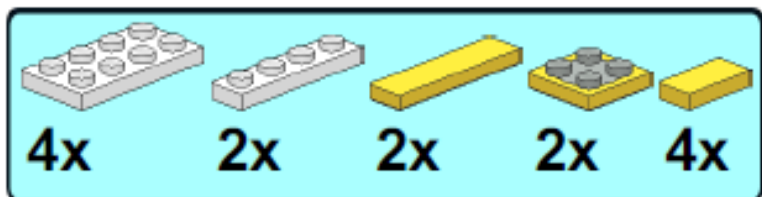

STEP 10

USS MAINE

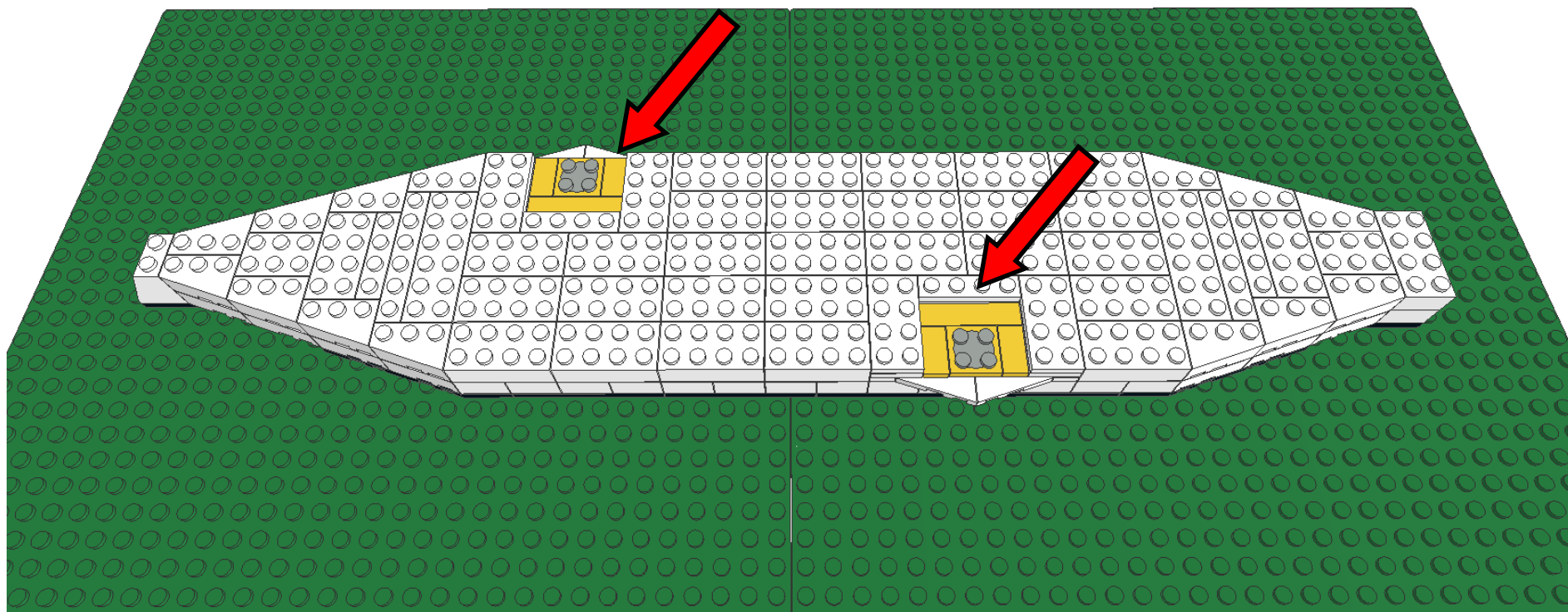
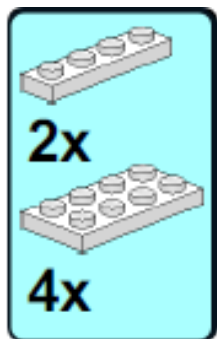

STEP 11

USS MAINE

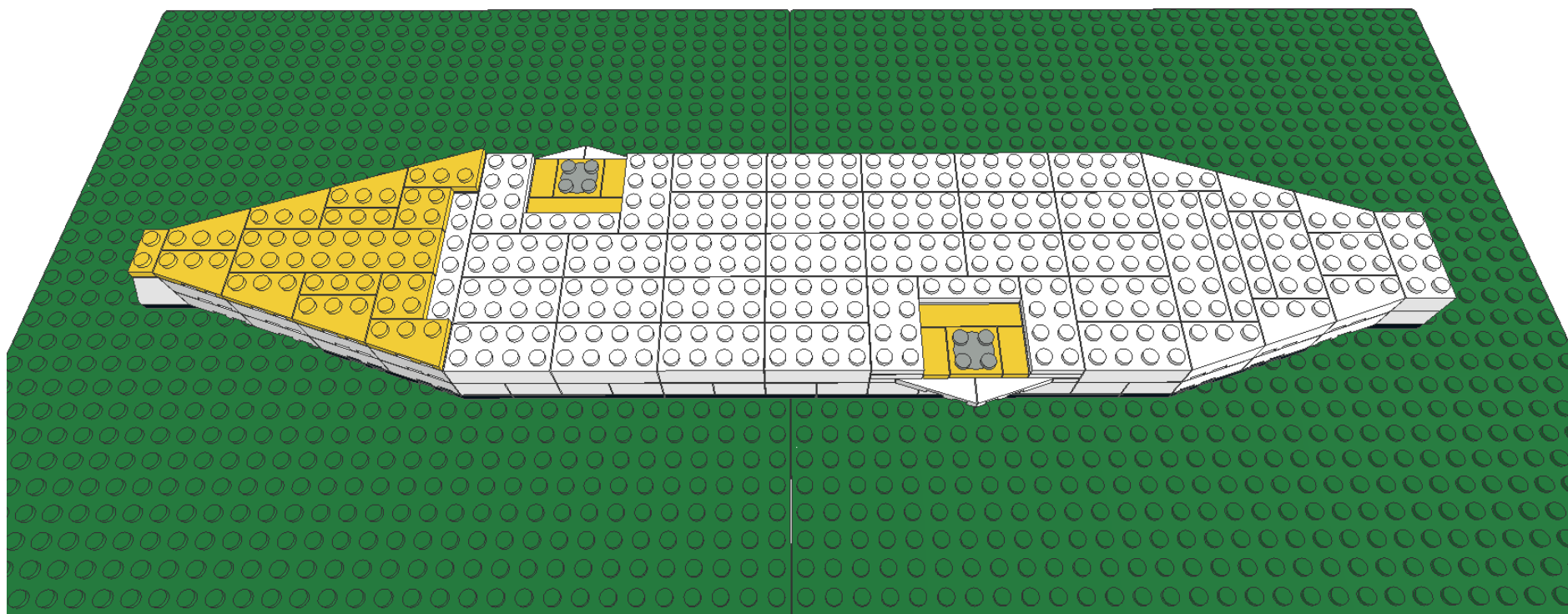
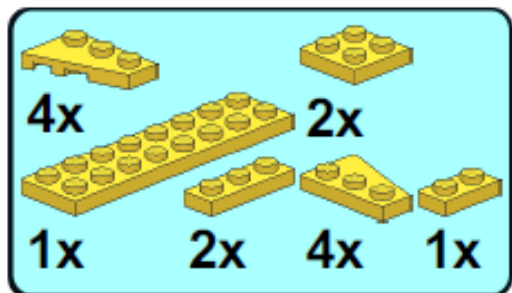

STEP 12

USS MAINE

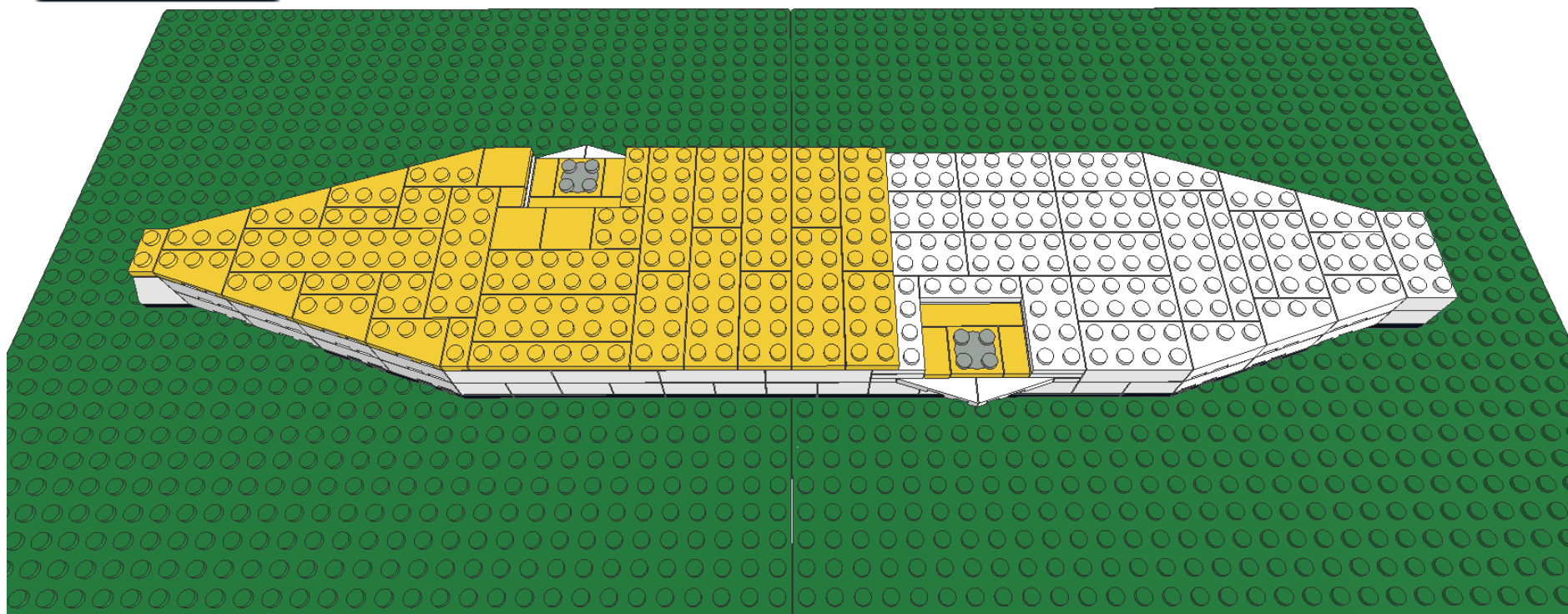
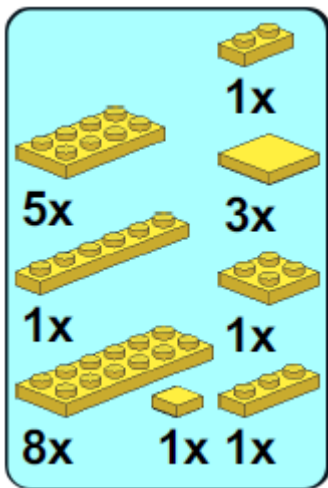

STEP 13

USS MAINE

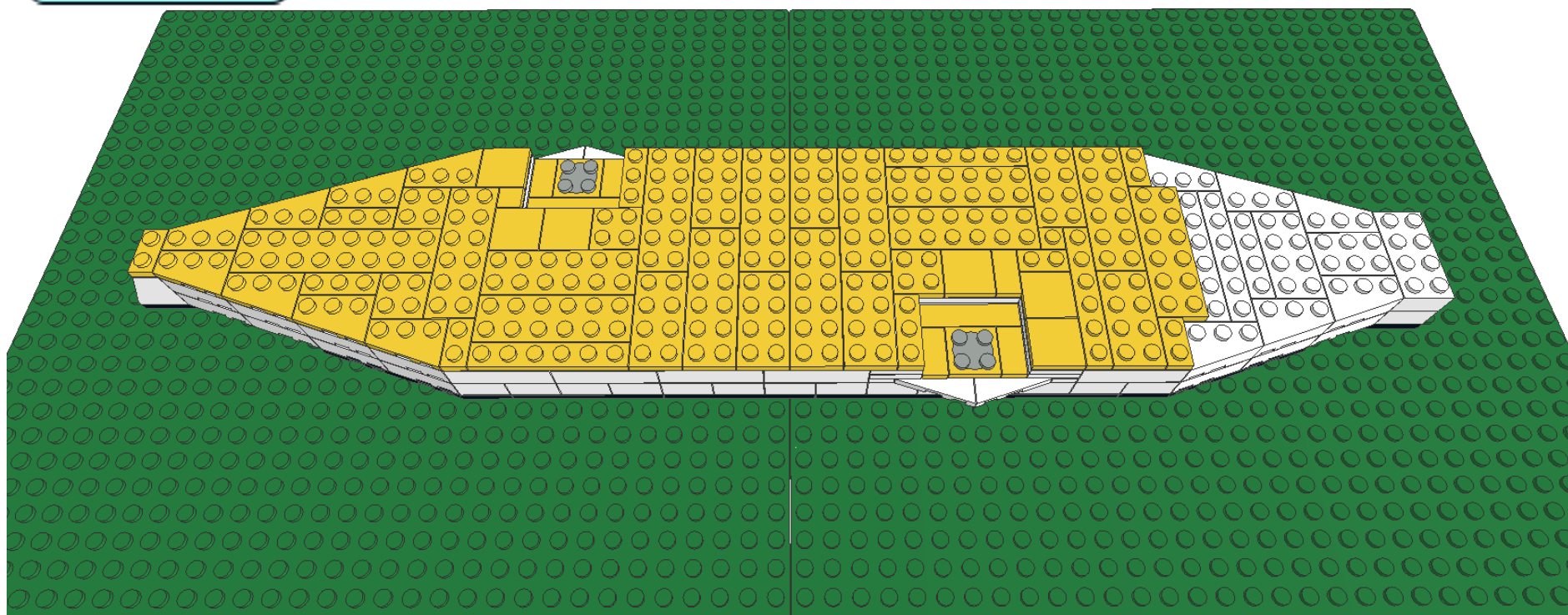
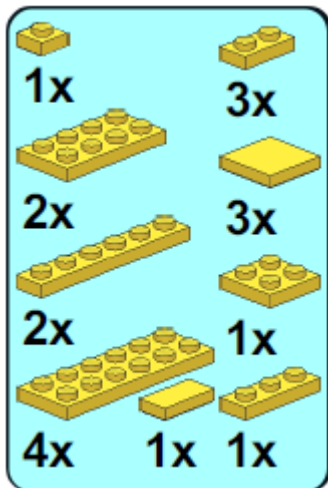

STEP 14

USS MAINE

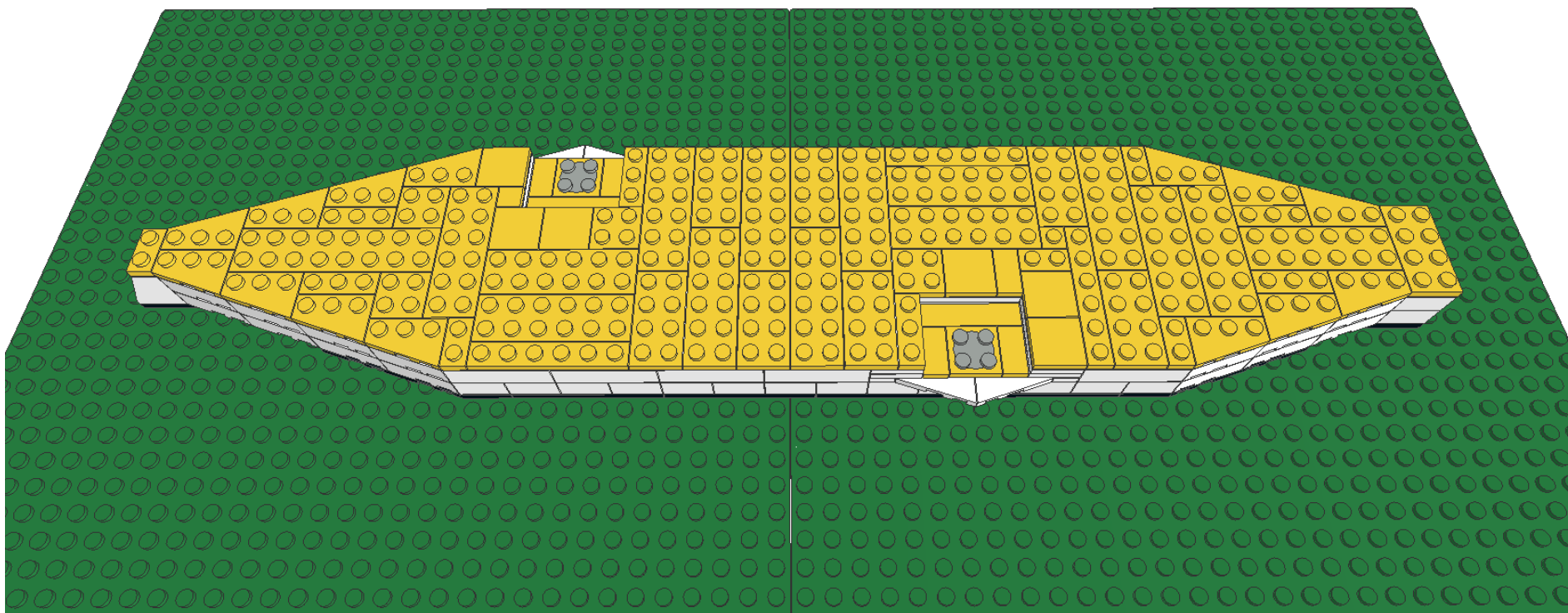
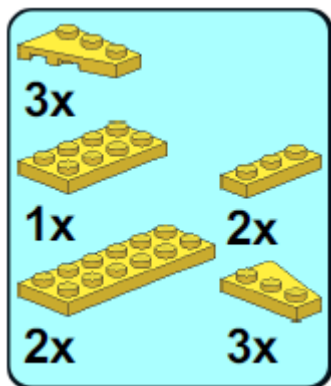

STEP 16

USS MAINE

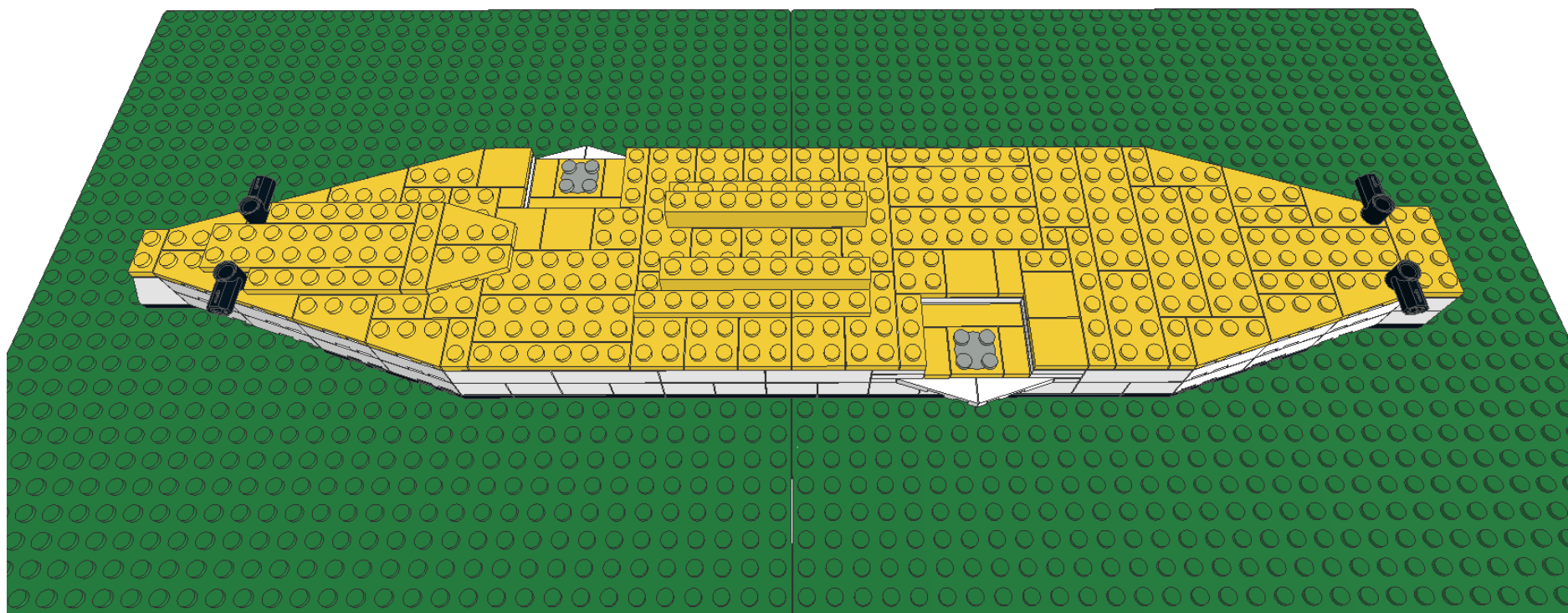

STEP 17

USS MAINE

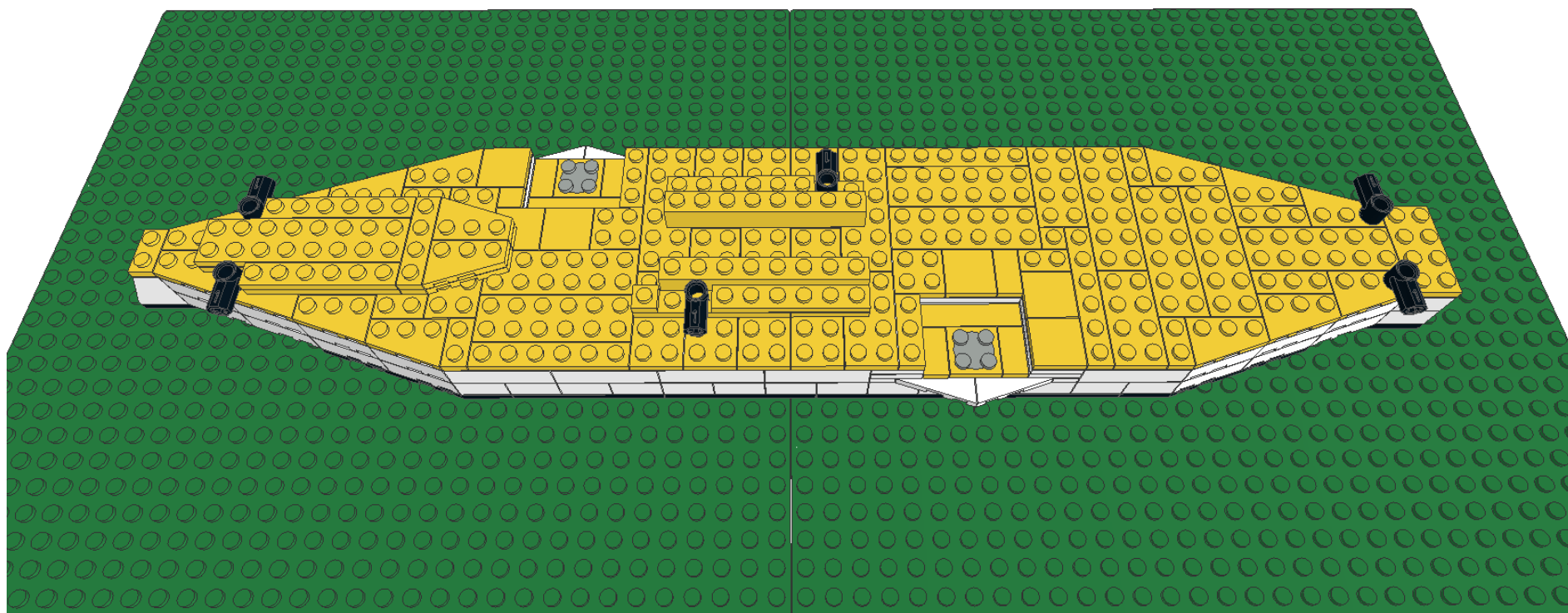
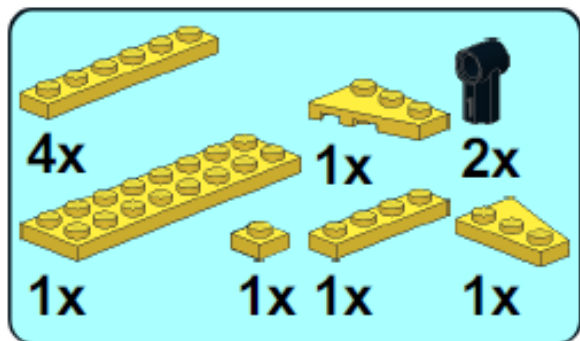

STEP 18

USS MAINE

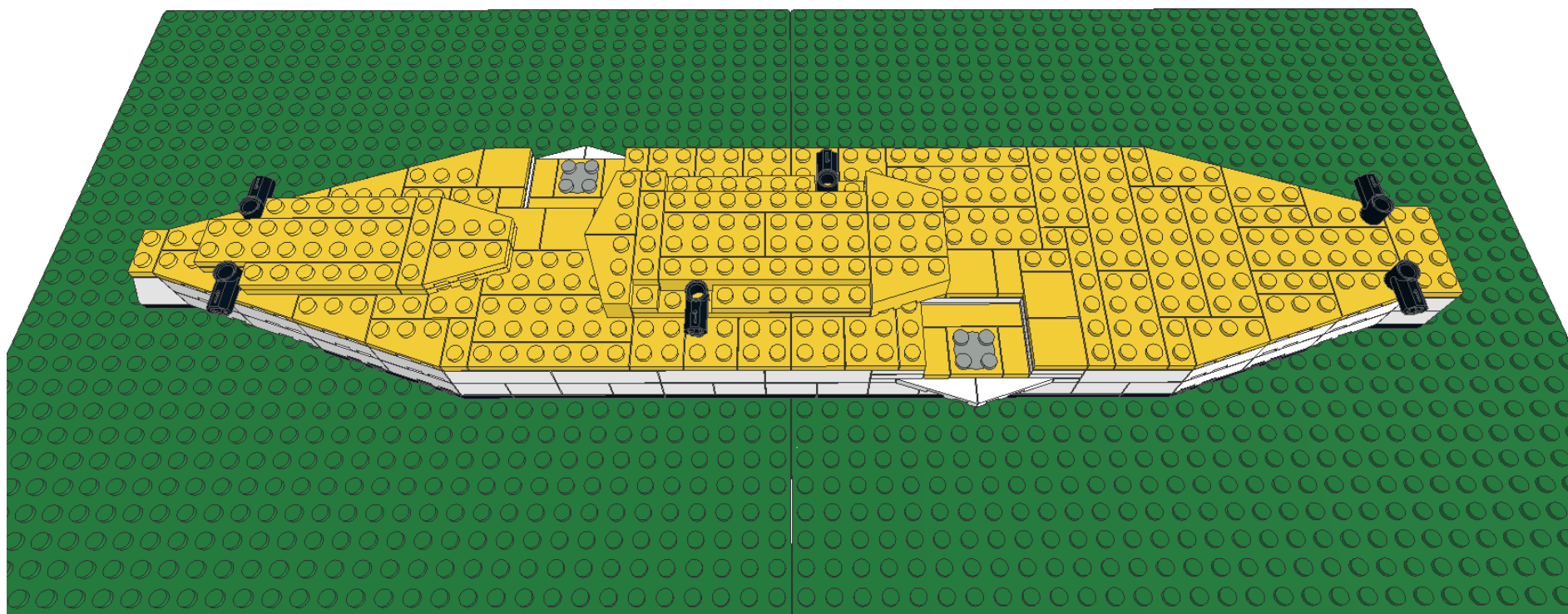
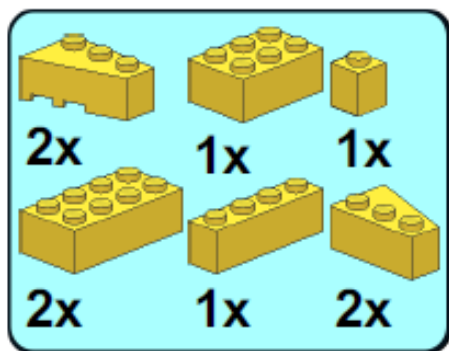

STEP 19

USS MAINE

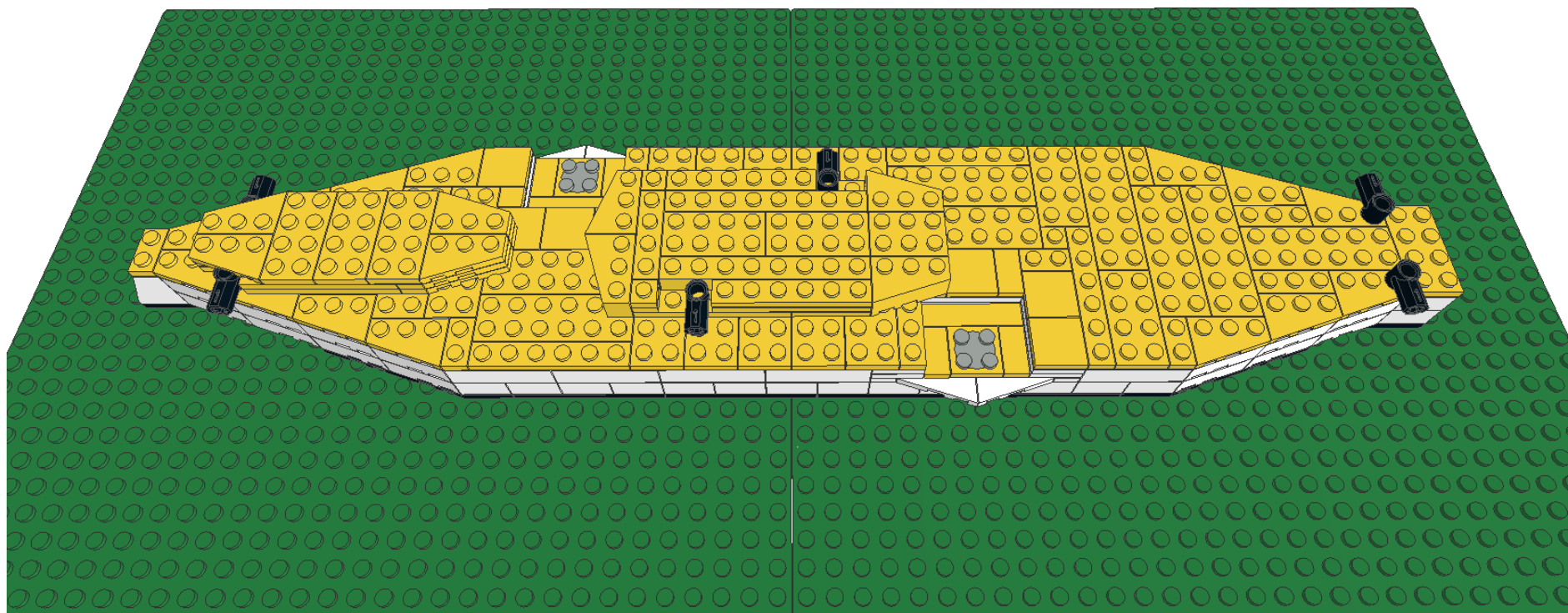
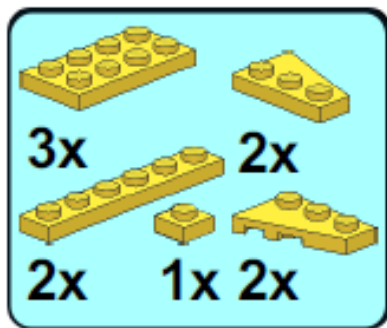

STEP 20

USS MAINE

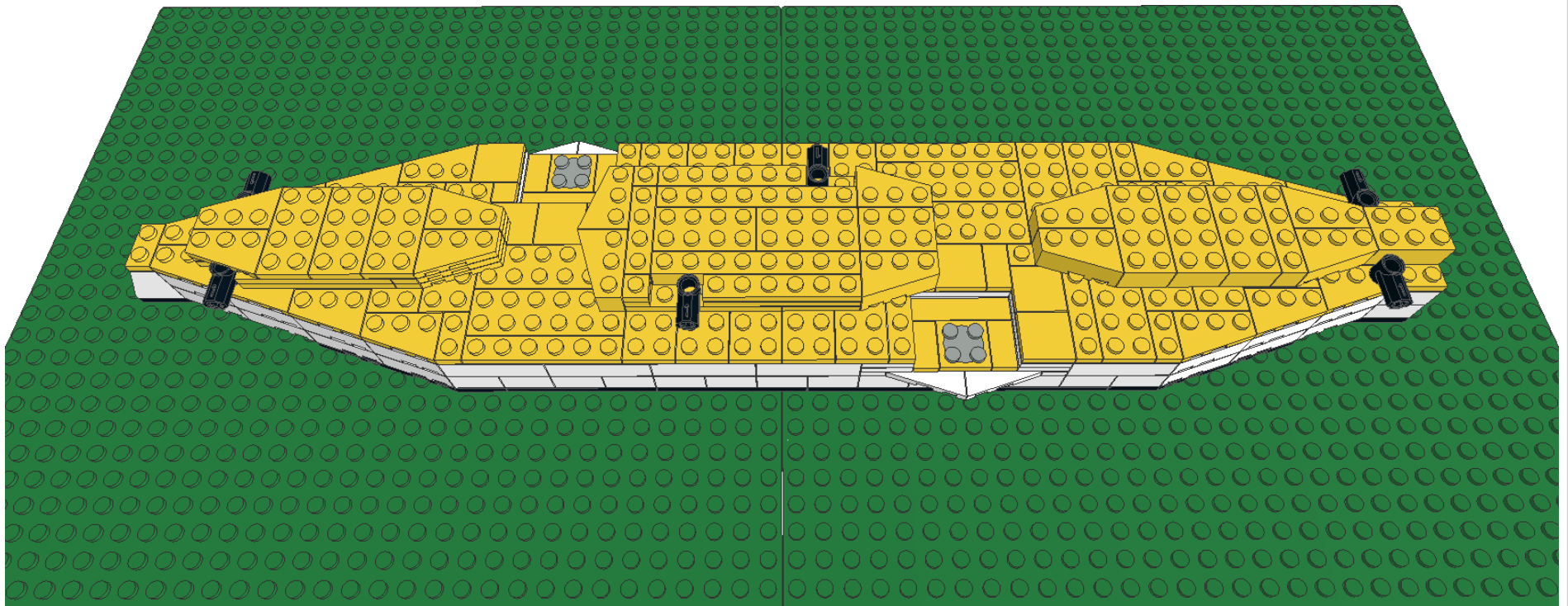
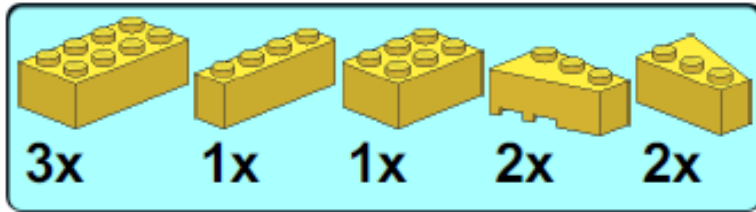

STEP 22

USS MAINE

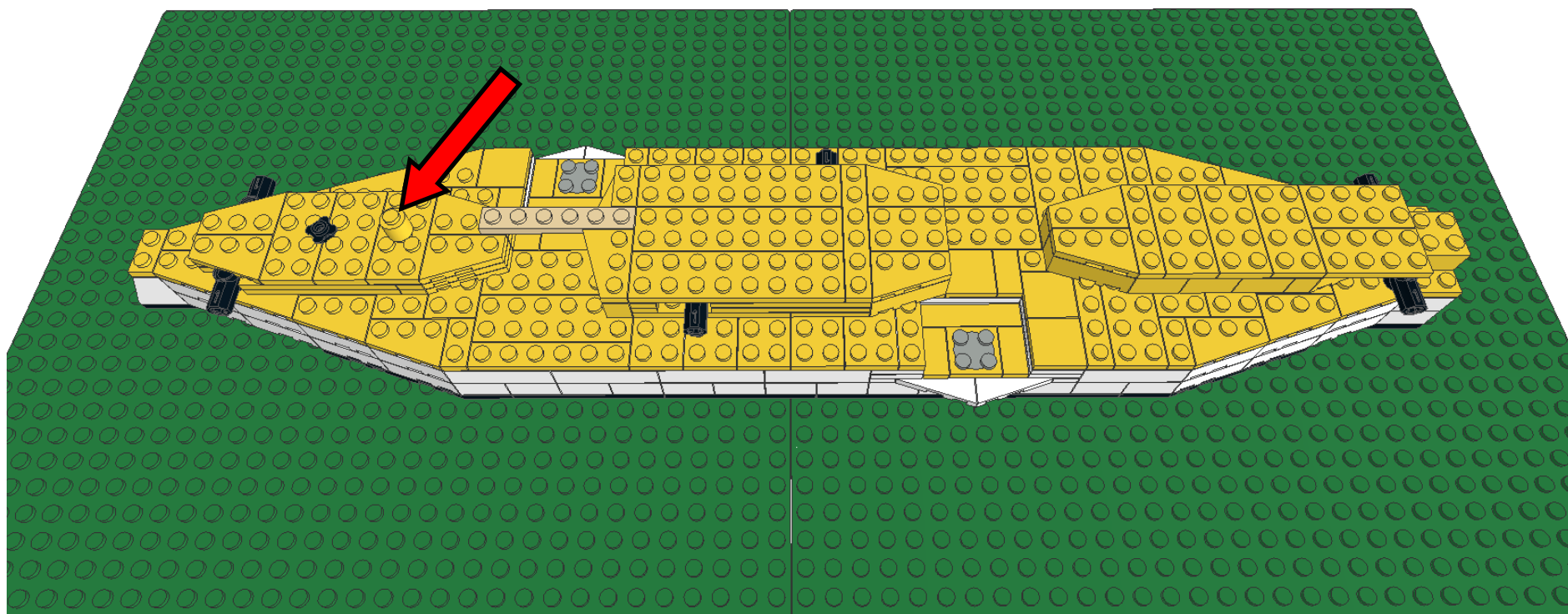

STEP 23

USS MAINE

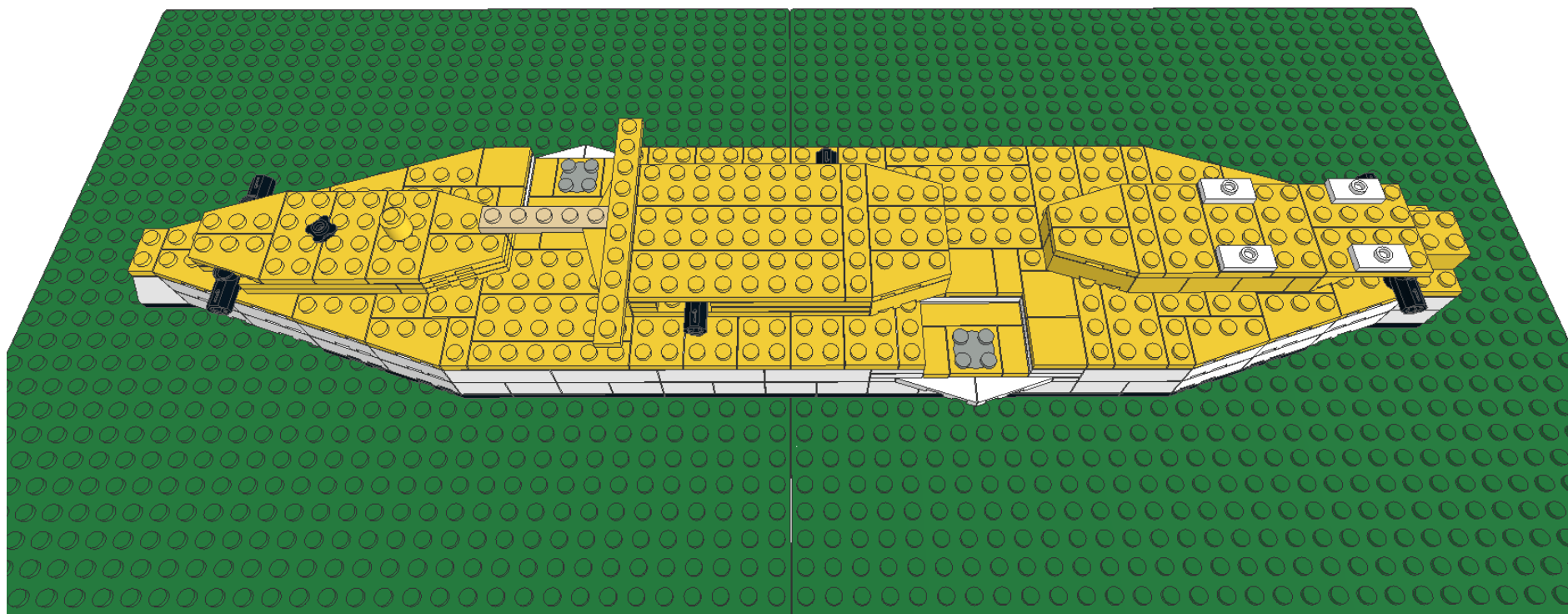
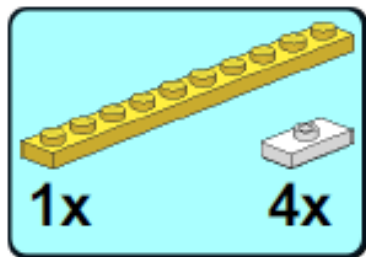

STEP 24

USS MAINE

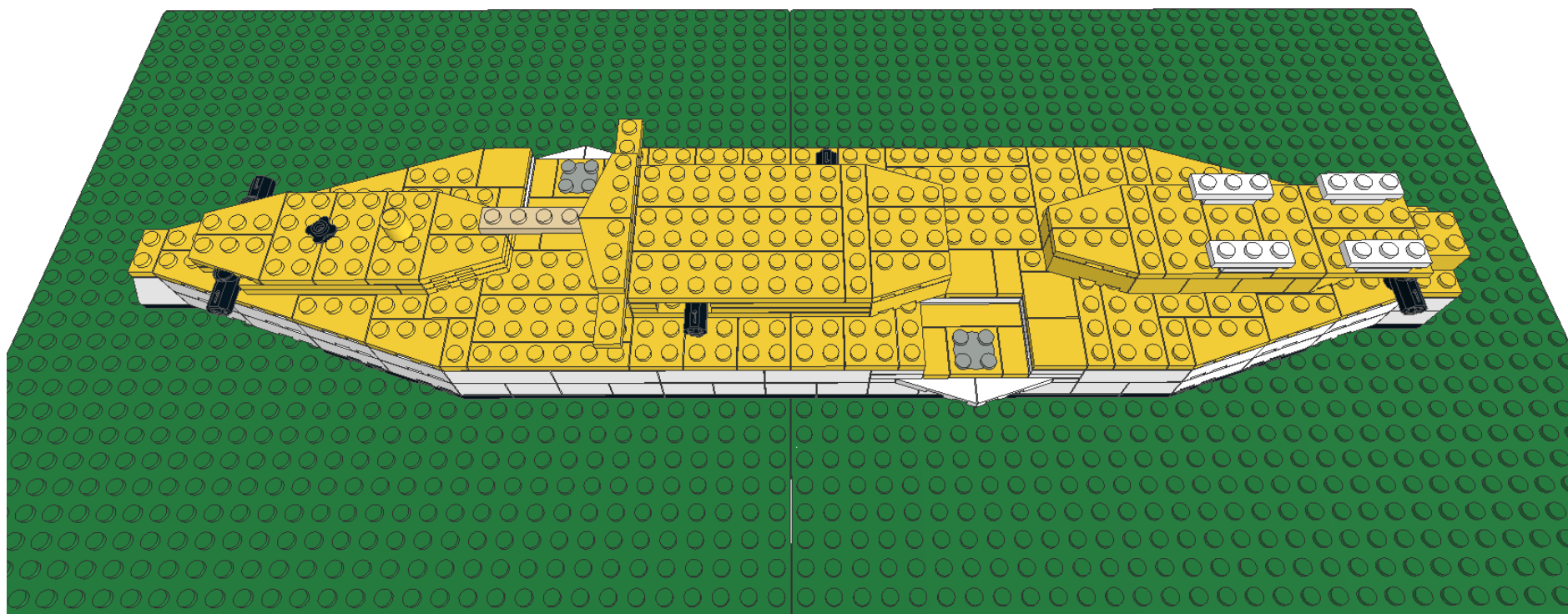
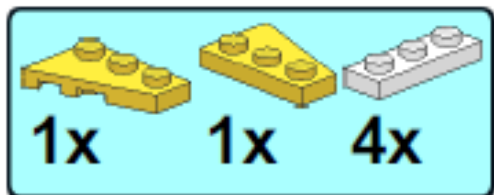

STEP 25

USS MAINE

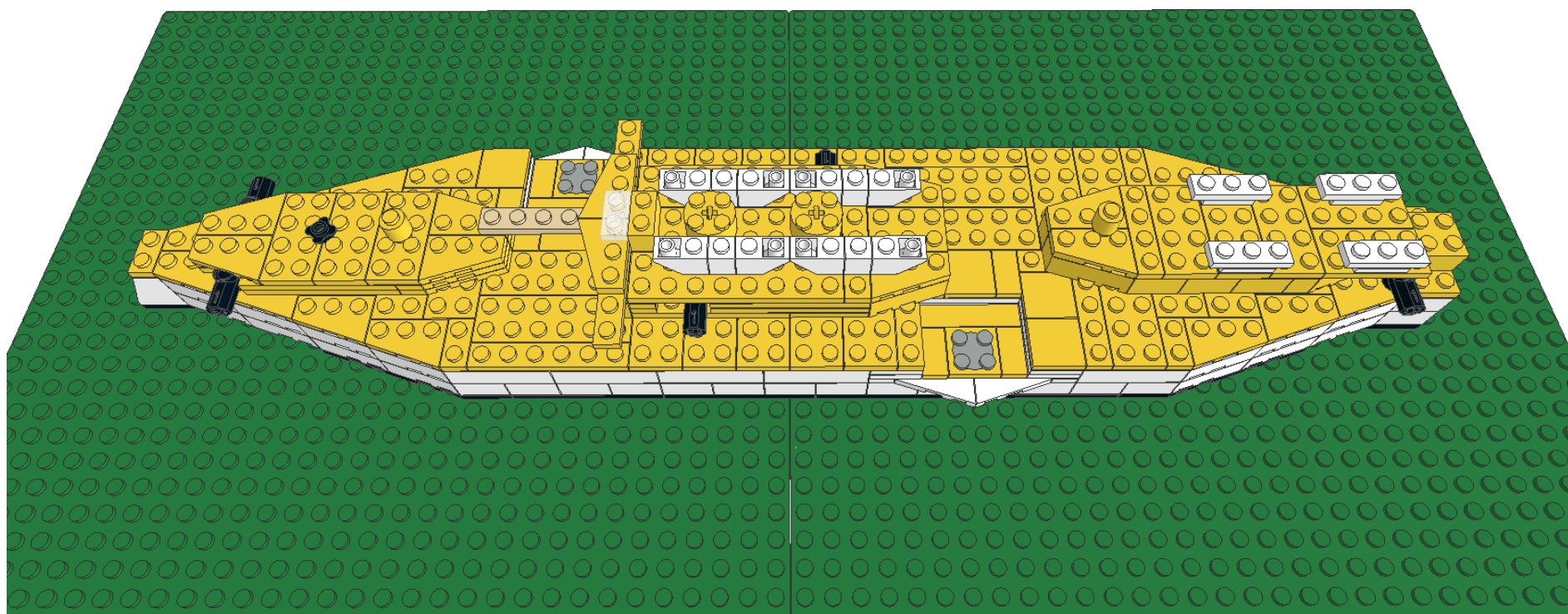
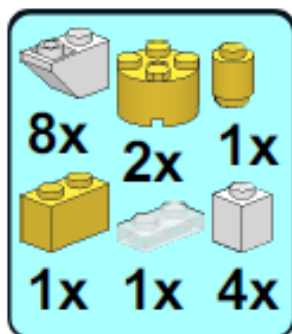

STEP 26

USS MAINE

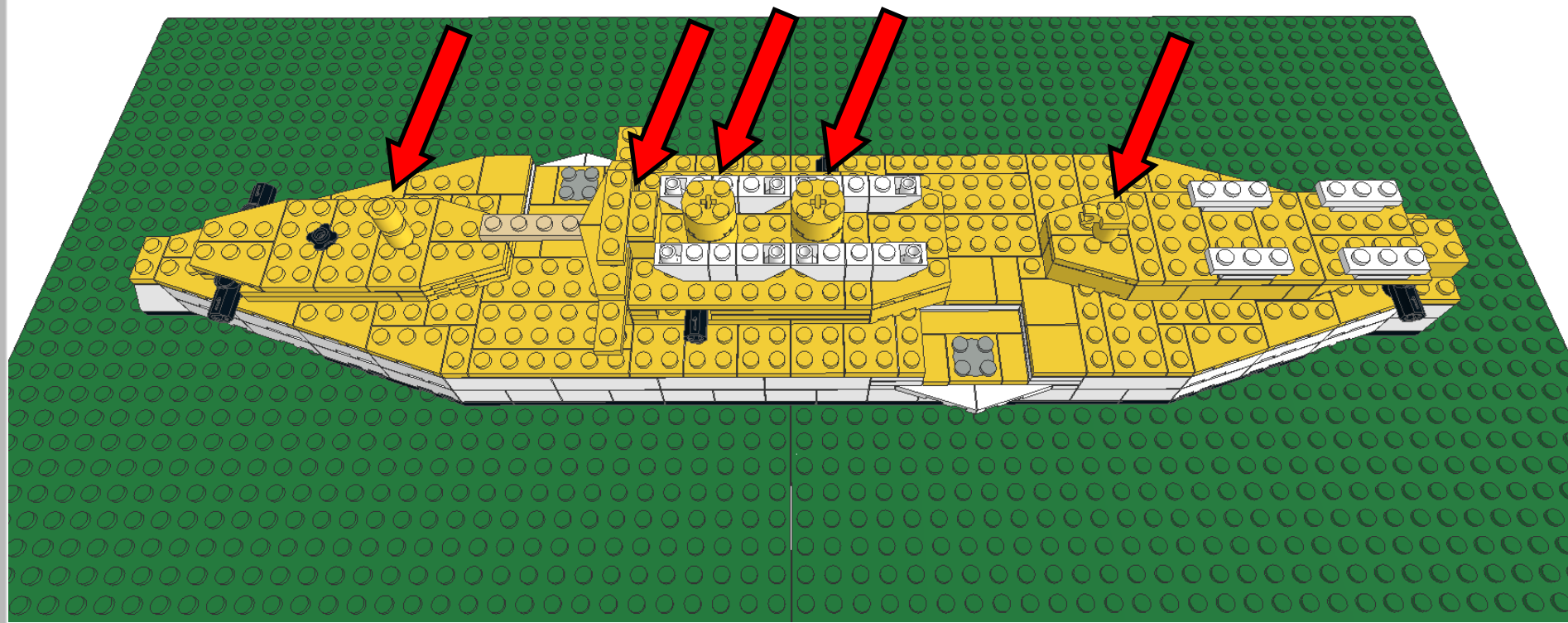
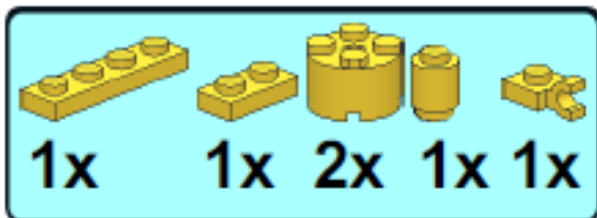

STEP 27

USS MAINE

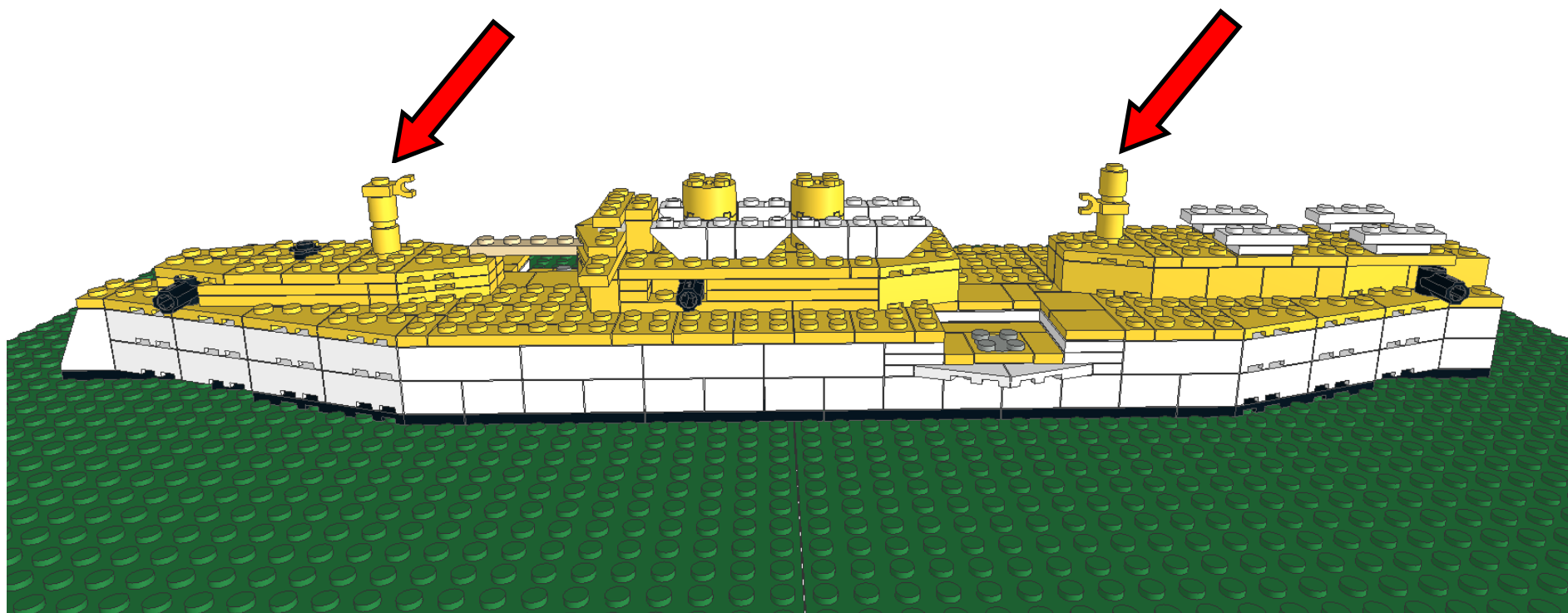
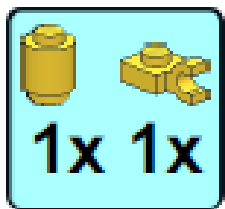

STEP 28

USS MAINE

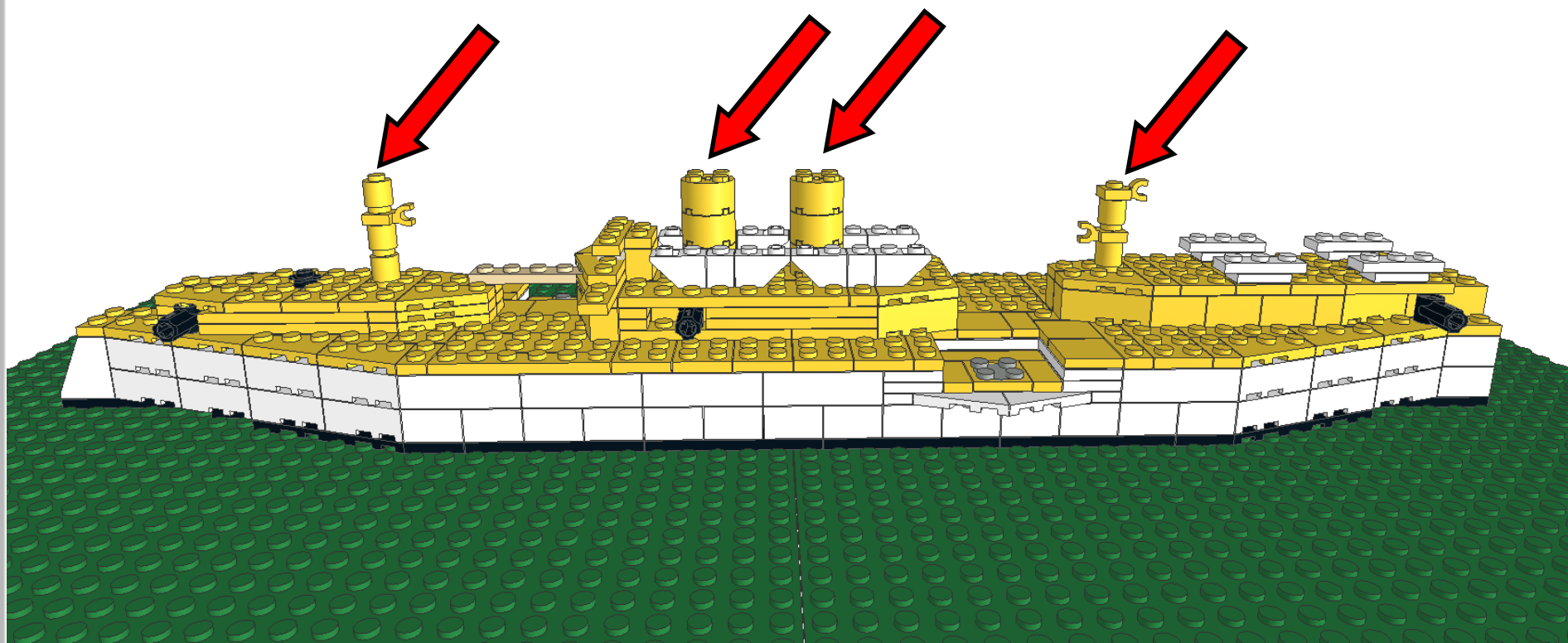
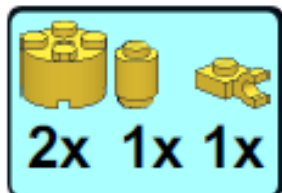

STEP 29

USS MAINE

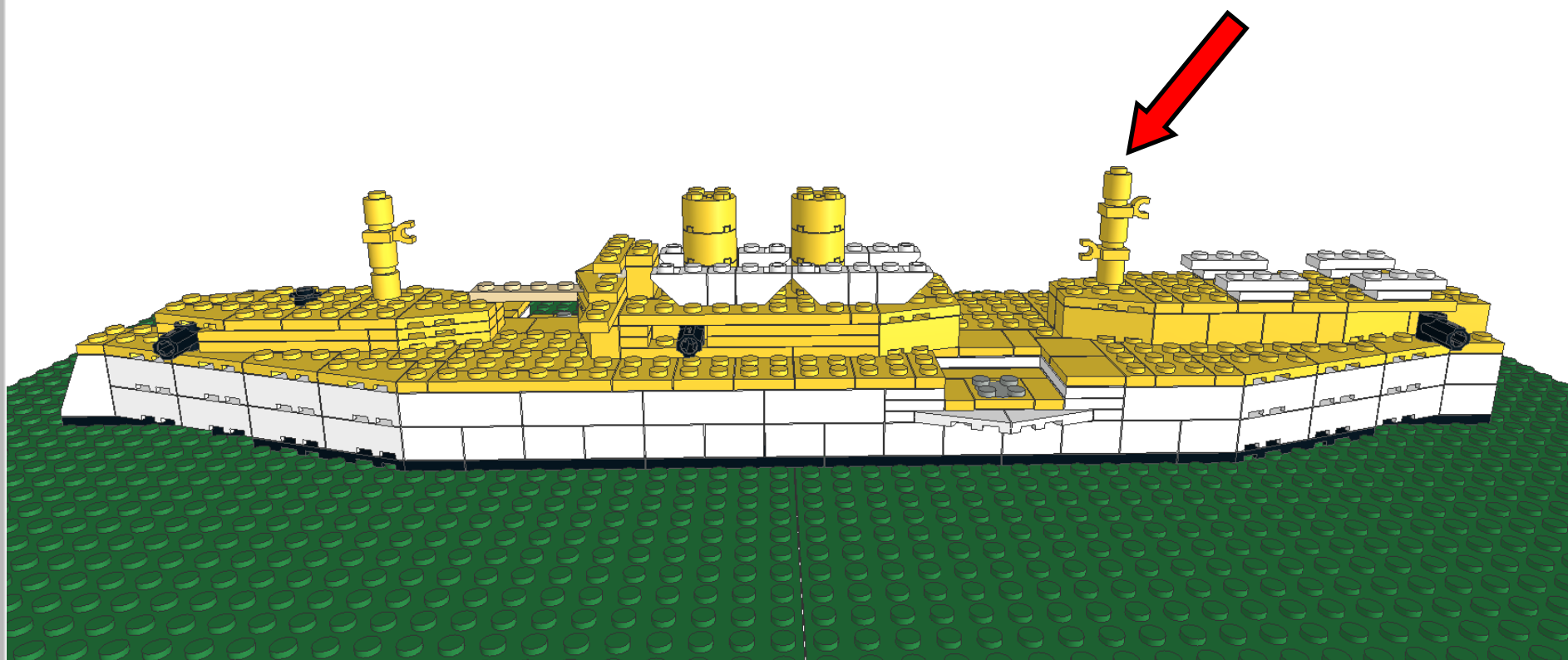

STEP 30

USS MAINE

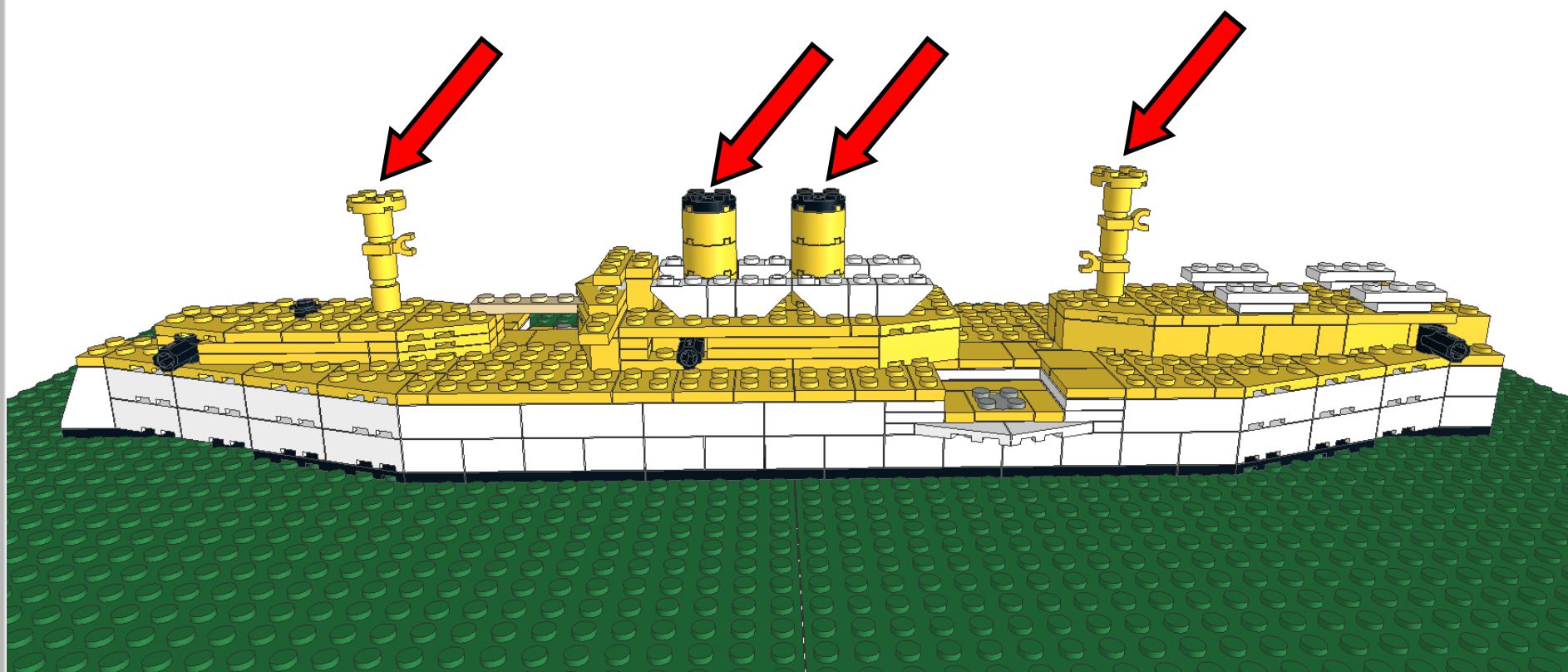

STEP 31

USS MAINE

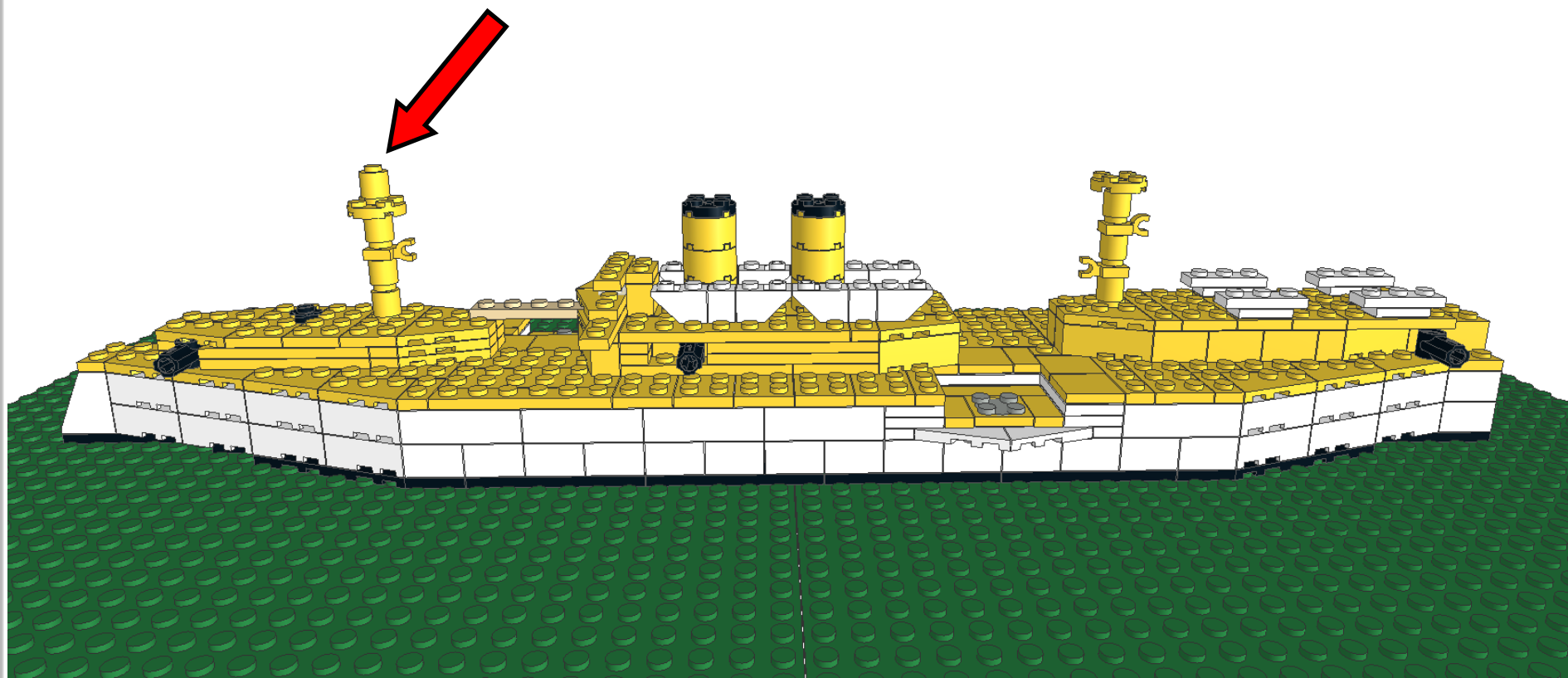

STEP 32

USS MAINE

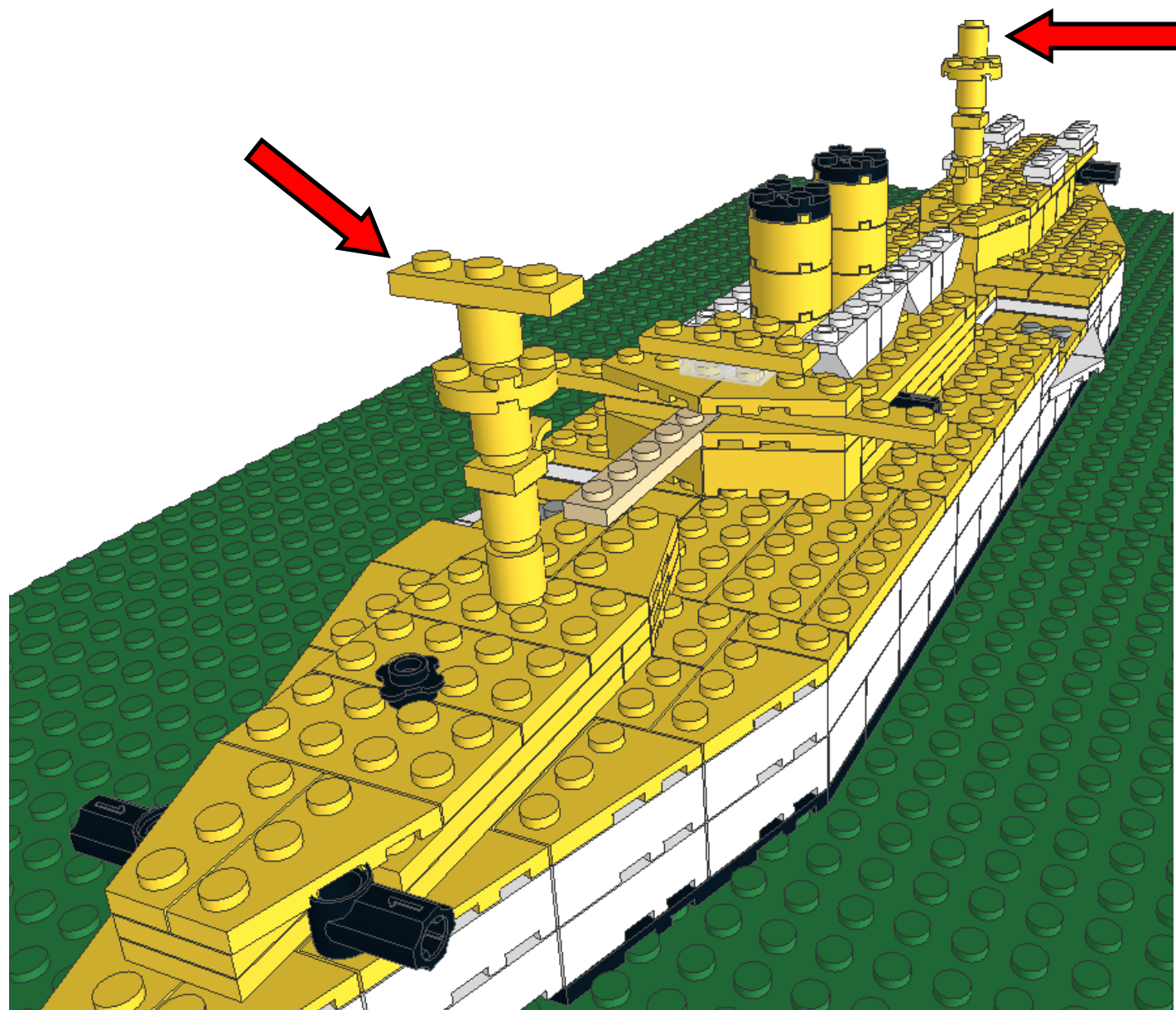
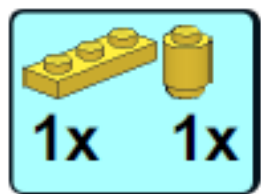

STEP 33

USS MAINE

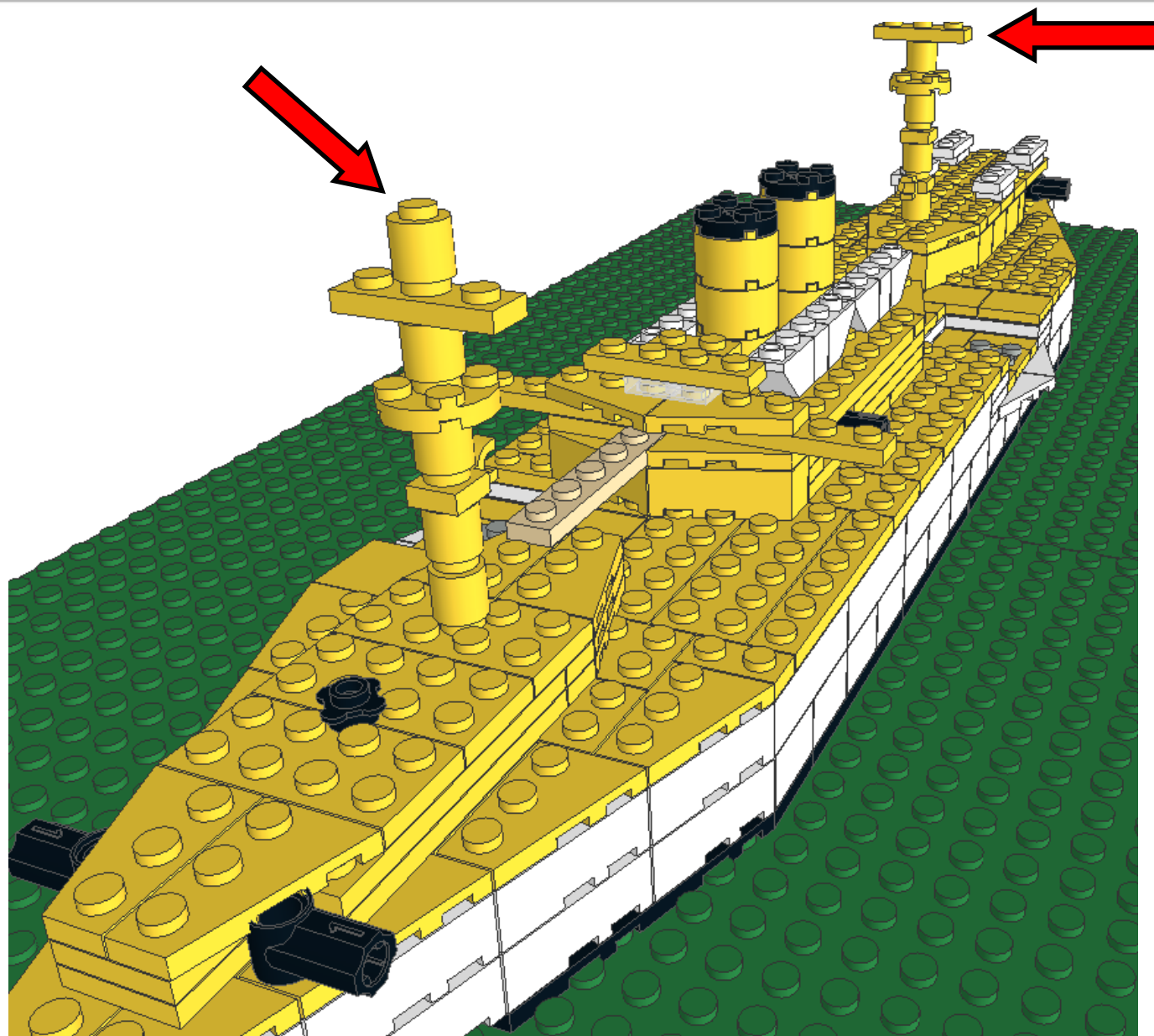
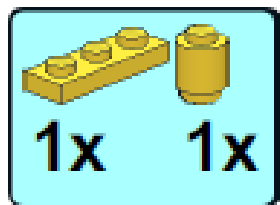

STEP 34

USS MAINE

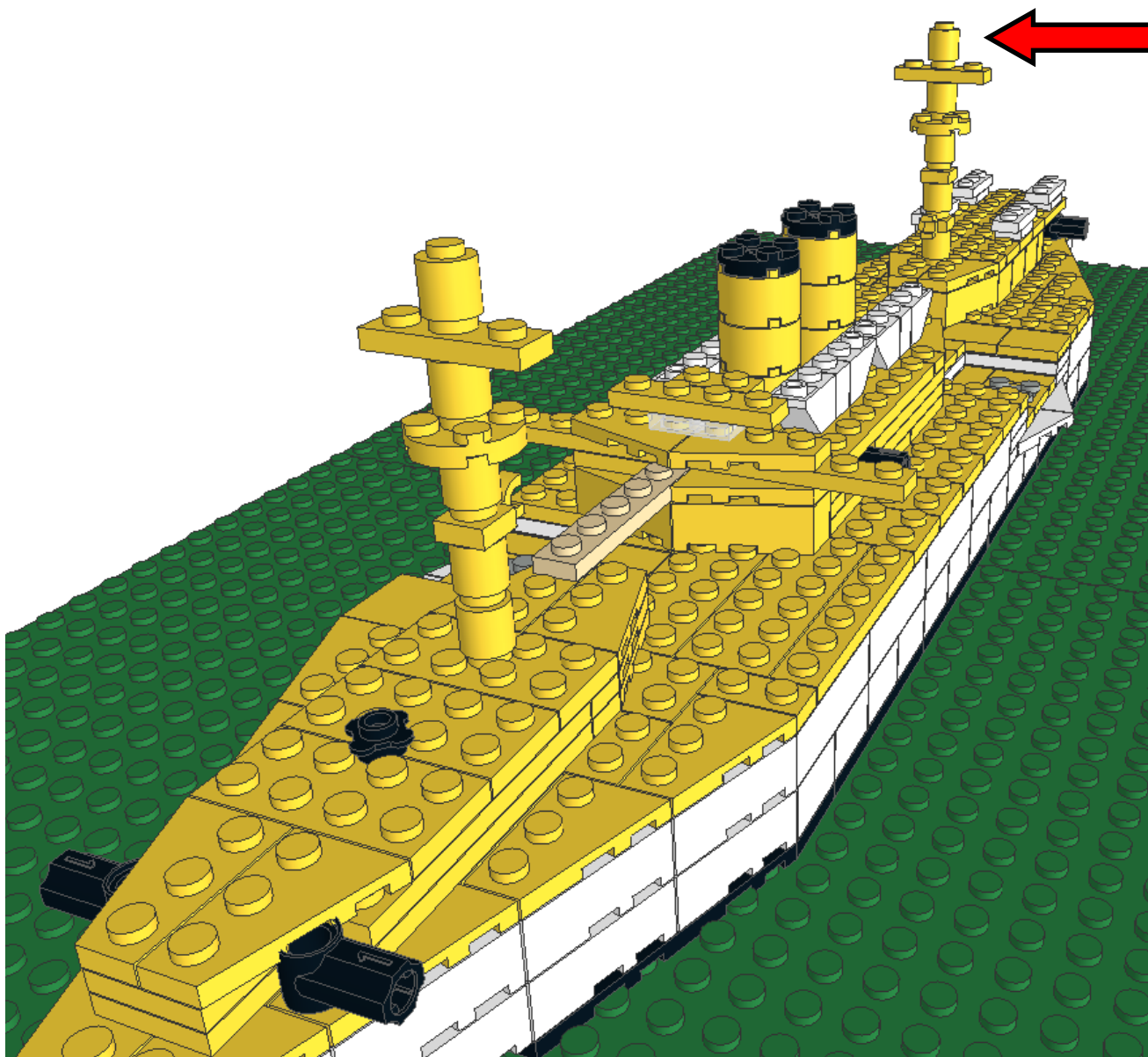

STEP 35-37

USS MAINE

35

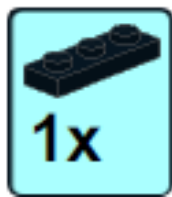

36

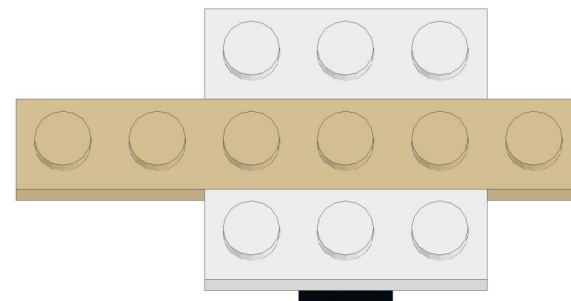
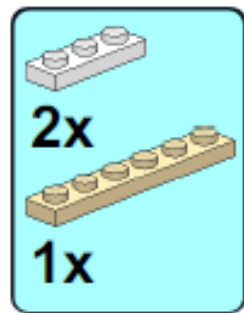

37

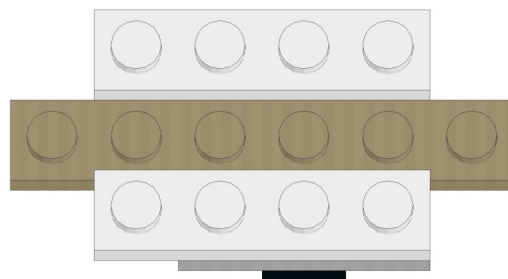
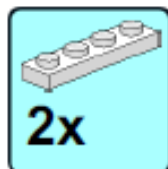

STEP 38

USS MAINE

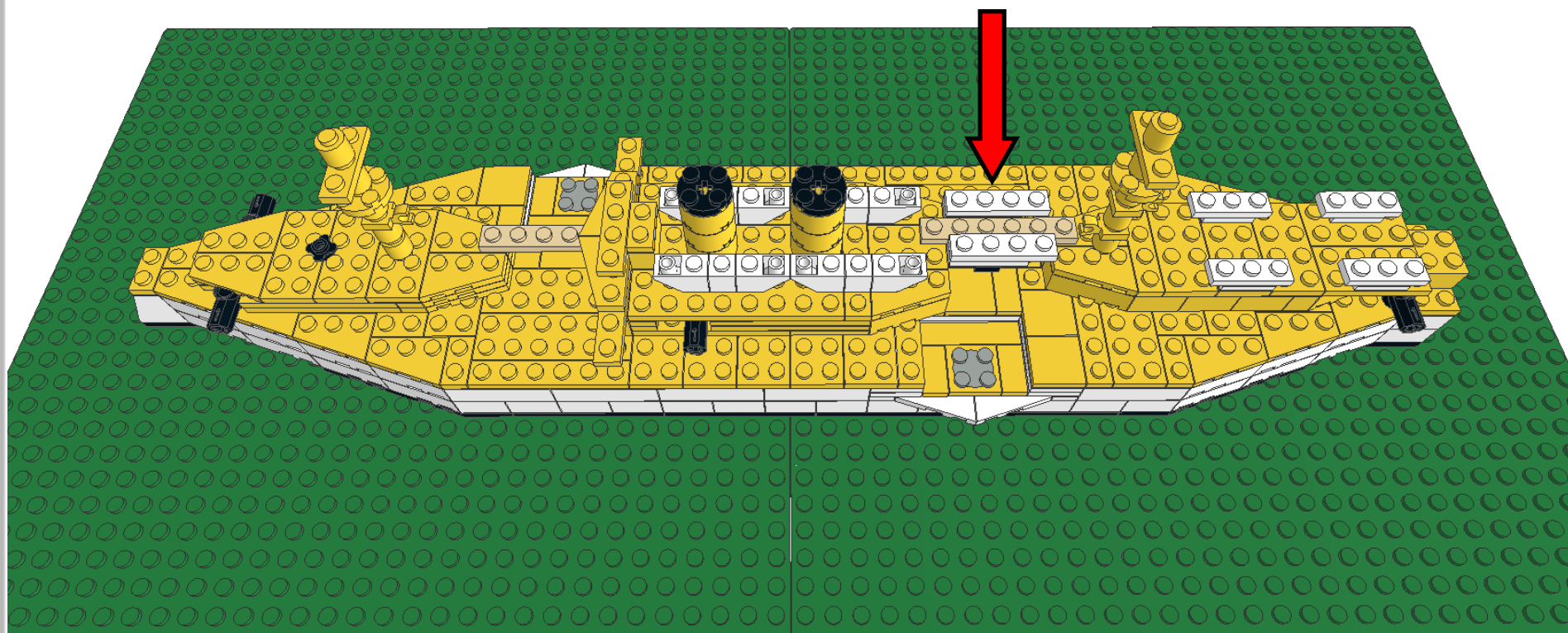
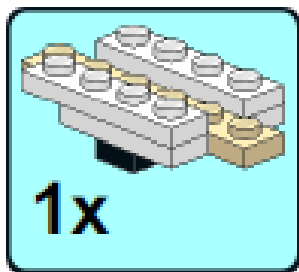

STEP 39-43

USS MAINE

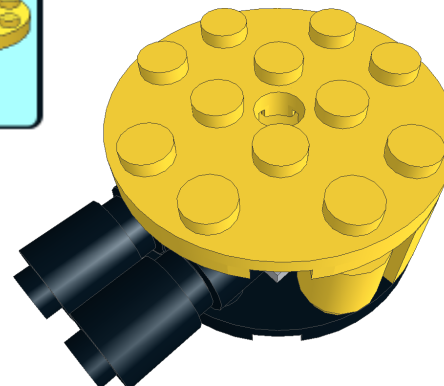
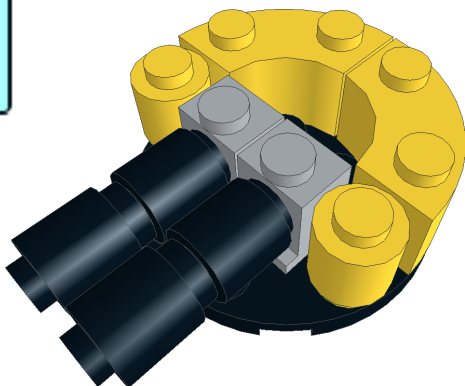
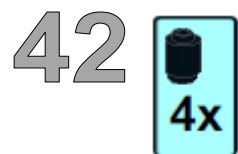
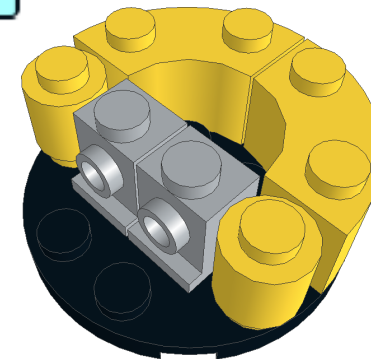
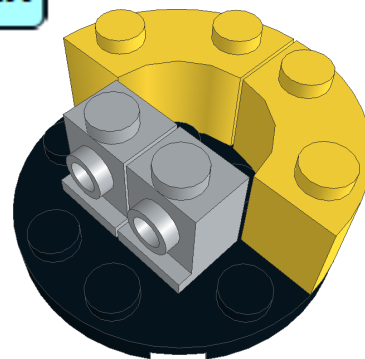
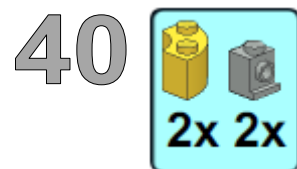
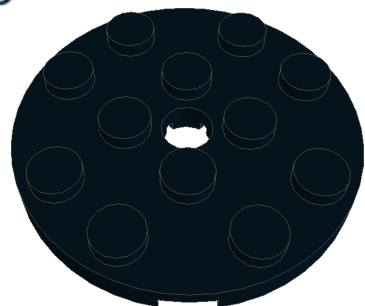
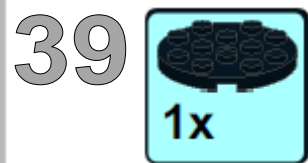

STEP 44

USS MAINE

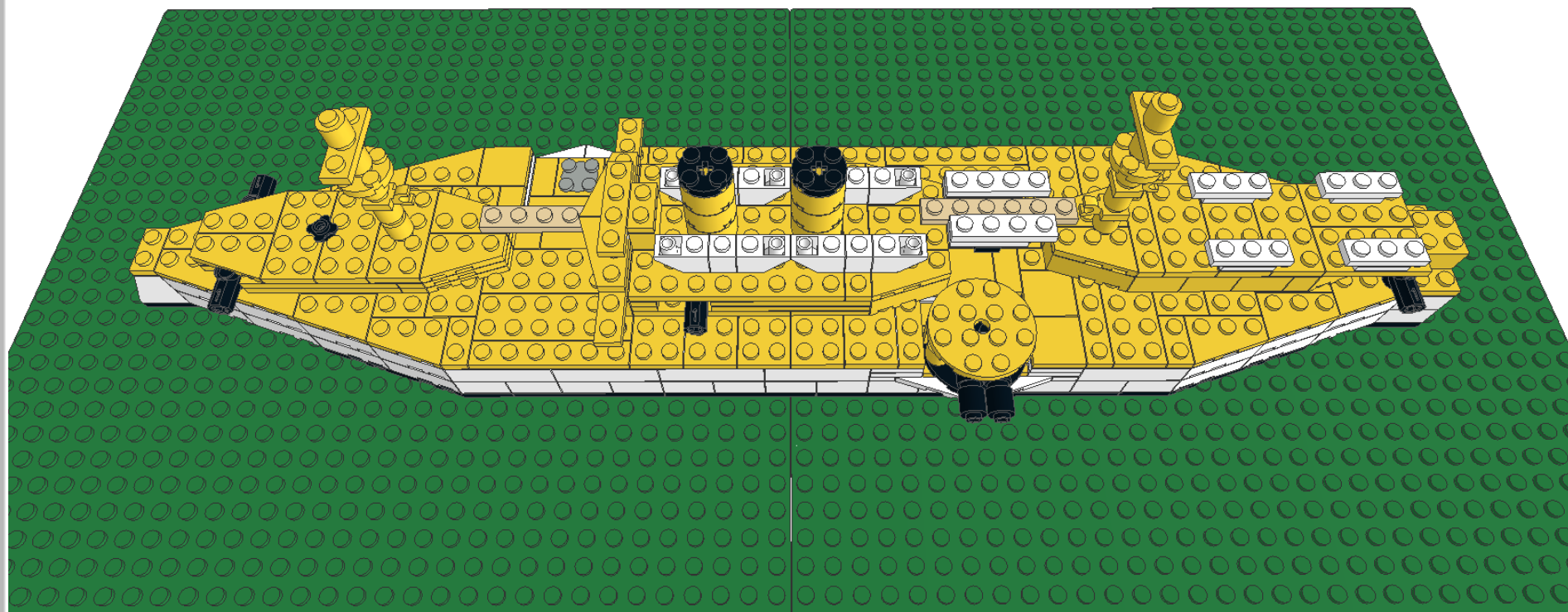

STEP 45

USS MAINE

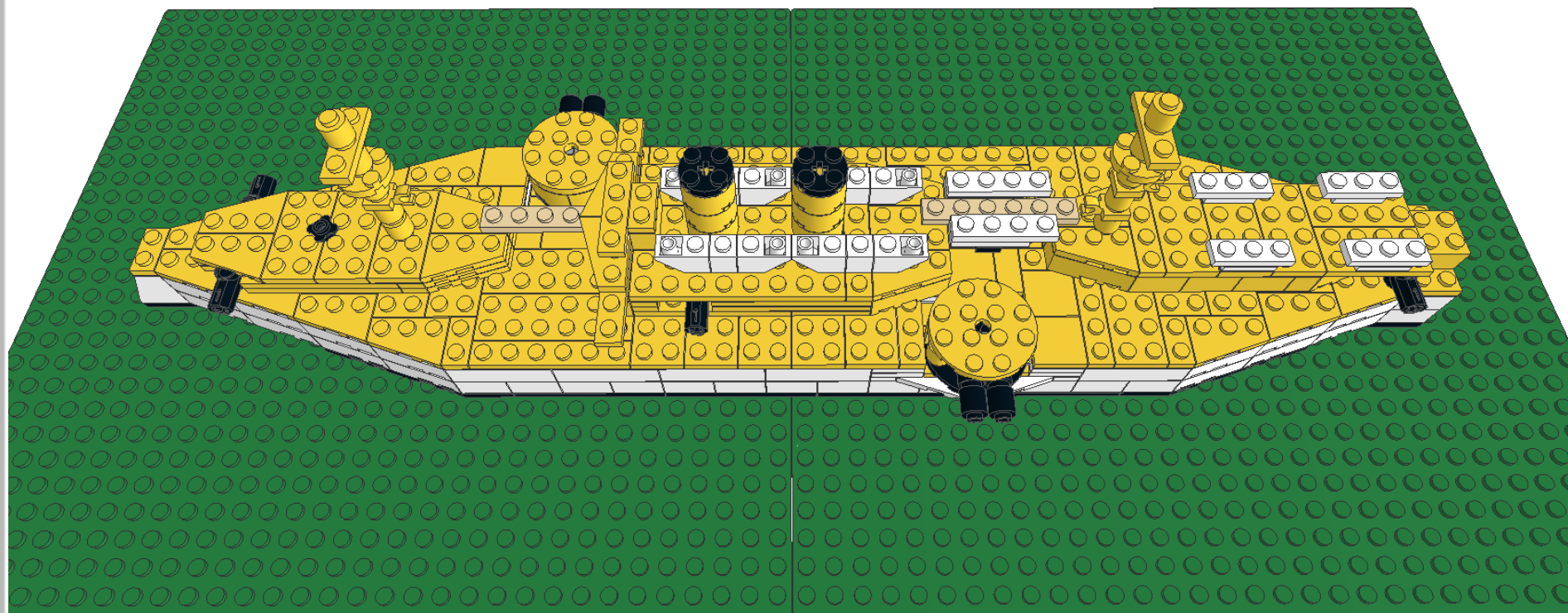

STEP 46

USS MAINE



**Insert the side edge
between pips
at a slight angle.**

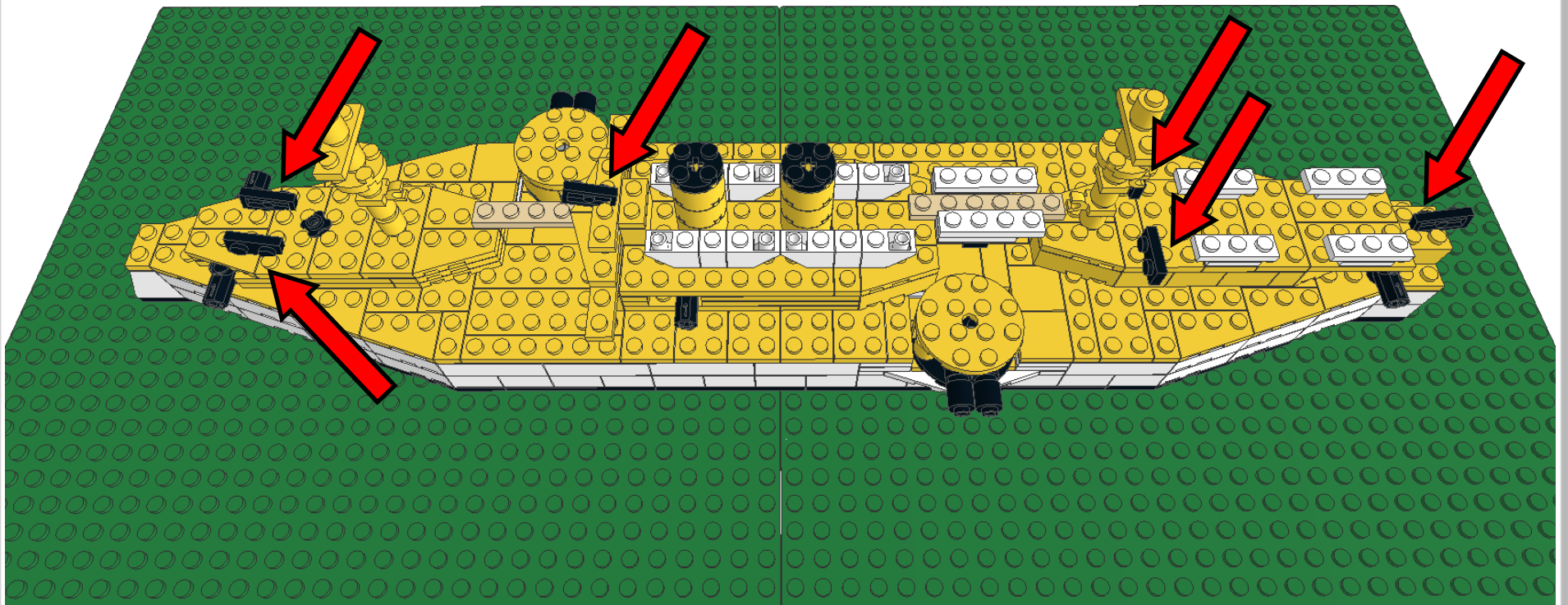

STEP 47

USS MAINE

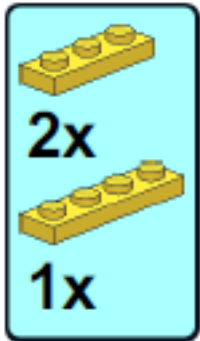

Insert the edge and rotate slightly down.

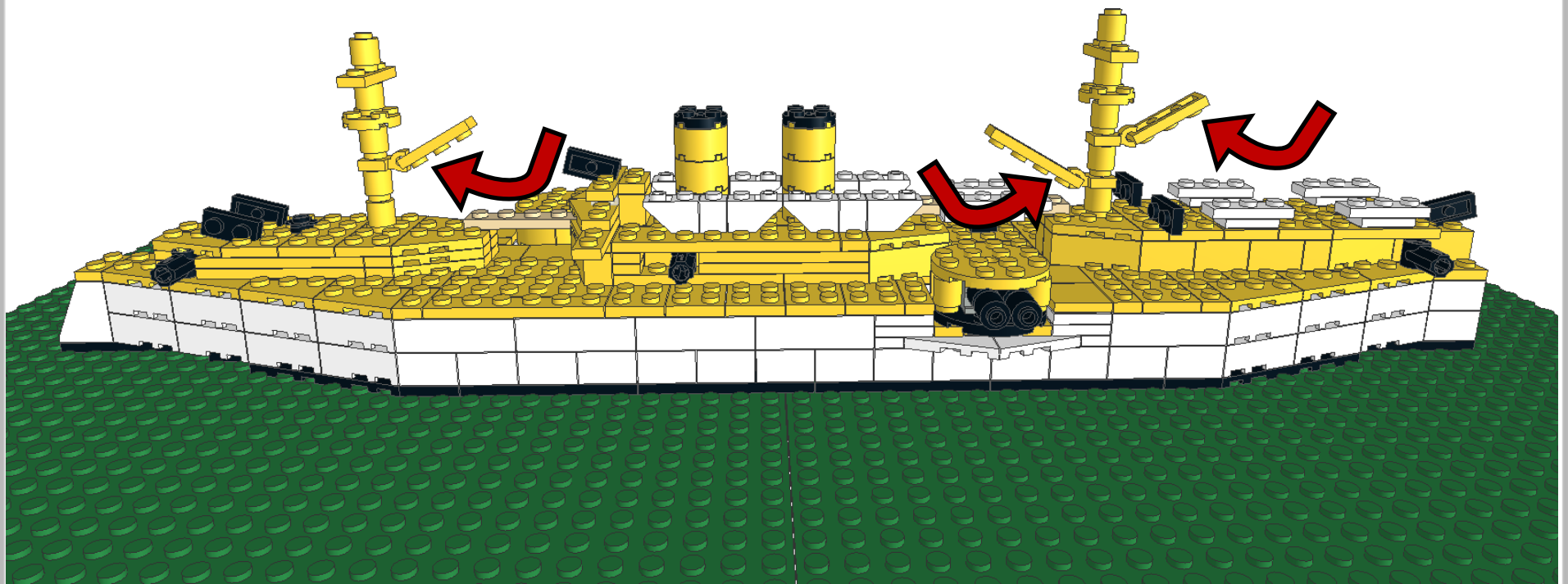

FINISHED

USS MAINE

